

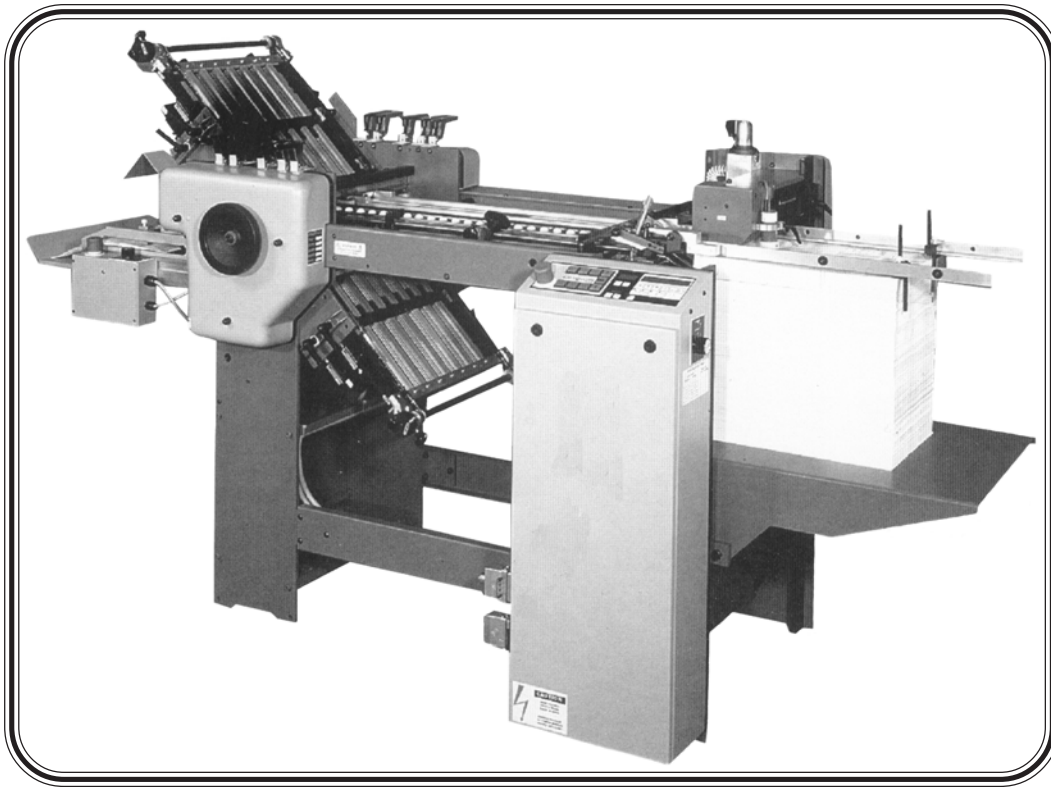

BAUMFOLDER



BAUM 2018

1ST STATION FOLDER W/PILE FEED

INSTRUCTION MANUAL

© 1999 BAUMFOLDER CORPORATION
All Rights Reserved

WARNING

- Do not operate this machine without all guarding in place.
- Do not make adjustments or perform maintenance on this machine with power on.
- Keep the machine and the work area clean and free of spills to prevent accidents.
- Be sure to replace any safety decals that may have been detached for any reason.

Baumfolder Corporation reserves the right to make changes in design or to make additions or improvements in its products without imposing any obligation upon itself to install them on its previously manufactured products. It is recommended that modifications to this equipment not be made without the advice and express written consent of Baumfolder Corporation.

FOLDER IDENTIFICATION

MODEL NO: _____ SERIAL NO: _____

SALES AGENCY: _____

INSTALLED BY: _____ DATE: _____

PHONE NO: _____

CONTENTS

DESCRIPTION	PAGE
I.) Safety	6
II.) Warning Labels	7
III.) Introduction Overview	8
IV.) Transportation/Installation	8
V.) Squaring the Machine	8
VI.) Electrical Connections	9
1.0. Wiring the Pump	9
1.1. Other Connections	9
1.2. Tapping the Transformer	9
1.3. Pump Connections	9
VII.) Installing Fold Plates & Stacker Delivery	10
VIII.) Operator Controls	10
1.0. Setting Folding Speed	10
1.1. Setting Stacker Belt Speed	10
1.2. Emergency Stop Button	10
1.0 Control Panel BAN-5	11
1.1. Displays	11
1.2. Machine Status Indicators	11
1.3. Machine Control Pushbuttons	11
1.4. Keypad Buttons with Selection Indicators	12
1.5. Keypad Buttons for Selection Adjustments	12
2.0 RUN MODE FUNCTIONS	12
2.1. Machine Setup and Diagnostic Mode	12
2.2. Counter Setup Mode	16
2.3. Easy Mode and Continuous Cycle Mode	17
2.4. Learn Mode	17
2.5. Make Ready Mode	18
2.6. Network Job Mode	19
2.7. Production Mode	19
3.0 LOGIC BOARD STATUS INDICATORS	20
4.0 Process Variables Definitions	21
4.1. Total Input Count	21
4.2. Total Output Count	21
4.3. Batch Down Count	21
4.4. Number of Batches	21
4.5. Current Rate	21
4.6. Main Drive Run Time	21
4.7. Main Drive Velocity	21
4.8. Waste Count (DCT500)	21
5.0 COUNTER SETUP VARIABLES	21
5.1. Batch Preset	21
5.2. Batch Output Type	21
5.3. Batch Output Time	22
5.4. Sheet Length	22
5.5. Gap Length	22
5.6. Suction Length	22
6.0 SYSTEM MESSAGES AND RUN MESSAGES	23
6.1. Power-Up Fault Messages	23
6.2. Run Time Fault Messages	24
6.3. Machine Run Error Messages	25

CONTENTS

DESCRIPTION	PAGE
IX.) Pile Feeder Operation	26
1.0 . Loading	26
1.1 . Hold-down Locations	26
1.2 . Air and Vacuum Setting	26
1.3 . Front Blow Tube Settings	27
1.4 . Vacuum Wheel	27
X.) Register Operation	28
1.0 . Double Sheet Detector	28
XI.) Baumset Adjustment	29
1.0 . Adjusting Folding Rollers	29
XII.) Setting Fold Plates	30
XIII.) Setting Deflectors	30
XIV.) Stacker Operation	31
XV.) Scoring/Slitting/Perforating	32
1.0 . Slitter Shaft Removal	32
1.1 . Scoring	32
1.2 . Perforating	33
1.3 . Slitting	34
1.4 . Trimming	35
XVI.) Lubrication/Maintenance	36
XVII.) Technical Specifications	37
XVIII.) Accessories	37
XIX.) Troubleshooting	38
XX.) Operating Tips	40
XXI.) Principles of Mechanical Folding	42
XXII.) Folding Chart	43
XXIII.) Manual Usage	45
XXIV.) Typical Layout & Sheet Orientation	46
XXV.) Impositions	47
#1 4 - PAGE	47
#2 4 - PAGE, DOUBLE IMPOSITION	47
#3 6 - PAGE, STANDARD	47
#4 6 - PAGE, ACCORDION	47
#5 8 - PAGE, PARALLEL IMPOSITION	47
#6 8 - PAGE, RIGHT ANGLE	47
#7 8 - PAGE, RIGHT ANGLE OBLONG	48
#8 8 - PAGE, RIGHT ANGLE DOUBLE IMPOSITION	48
#9 8 - PAGE, PARALLEL OVER & OVER	48
#10 12 - PAGE BOOK, SADDLE STITCH	48
#11 12 - PAGE BOOK, SADDLE STITCH	48
#12 12 - PAGE LETTER FOLD, HEADS OUT	48
#13 12 - PAGE LETTER FOLD, HEADS IN	49
#14 12 - PAGE LETTER FOLD, ACCORDION	49
#15 16 - PAGE, THREE RIGHT ANGLE BOOK IMPOSITION	49
#16 12 - PAGE FOLDER, HEADS OUT	49
#17 24 - PAGE BOOKLET	49
#18 32 - PAGE BOOK	49
XXVI.) Service	50

List of Tables

DESCRIPTION	PAGE
Table 1. Machine Setup Parameter List "A"	13
Table 2. Machine Monitor Parameter List	13
Table 3. Machine Setup Parameter List "B"	14
Table 4. Machine Diagnostic Parameter List	15
Table 5. Future Features List	15
Table 6. Machine Usage Status Parameter List	16
Table 7. Output Type Animations	16
Table 8. Count Source Selection	17
Table 9. Learn Mode Status	17
Table 10. Suction Mode Symbols	18
Table 11. Suction Length Function	18
Table 12. Determining the Large Display Contents	19
Table 13. Reset mode Selection	19
Table 14. LED Status Indicators	20
Table 15. Output Delay and Duration	20
Table 16. Power Up Fault Messages	23
Table 17. Run Time Fault Messages	24
Table 18. Machine Run Error Messages	25



SAFETY FIRST



Your new Baum paper folding machine has been designed in accordance with the latest safety specifications. The warning and caution labels on the machine must remain in place. Make sure all guarding provided is in place before starting up and running the machine.

Due to the nature of the work process of paper folding machines, there are parts and areas on the machine which cannot be completely covered without interfering with the operation of the machine. Therefore, sound personal work habits and strict observance of all safety precautions is required for the protection of the operator, co-workers, and the machine.

Be sure to follow these safety precautions:

1. Study the safety instructions at your plant and those provided in this manual.
2. Study the operating instructions carefully before operating the machine.
3. Make sure that your co-workers are familiar with the work process, potential danger areas, and all necessary safety measures.
4. Make sure that the machine is in good working order before turning it on.
5. If the machine suddenly stops for whatever reason, do not restart it right away. Someone may have stopped the machine, but failed to press the emergency (Stop) button. If the machine is restarted unexpectedly, your co-worker could be seriously injured.
6. Always press the emergency (Stop) button first if you stop the machine for adjustments or maintenance work which must not be done while the machine is in operation.
7. For extensive maintenance or repair work, turn off the main power supply.
8. Never use improper or defective tools.
9. After making adjustments or after doing maintenance or repair work, always make sure that all tools and other objects are removed from the machine. Otherwise, they might fall into the machine, causing severe damage or injuries.
10. Make sure that all safety devices are in place before restarting the machine.
11. Never clean moving parts of the machine (rollers, shafts, etc.) or remove any test sheets or paper jams while the machine is running.
12. Keep the floor around the entire machine clean. Immediately clean up any oil, grease, or paint spills from the floor. Remove tools, cleaning cloths, and paper scraps from all work areas.
13. Never allow unauthorized personnel to make adjustments on the machine, remove problem sheets, or start the machine.
14. Never climb over the machine or crawl into it while it is turned on.
15. Immediately repair or replace any safety devices which have become ineffective or are missing.
16. Report any exposed cables or exposed electrical connections.
17. Always have a certified qualified electrician perform all electrical maintenance.
18. Do not make adjustments or perform maintenance with the power on.
19. Become familiar with and follow the safety labels on the next page. Replace any of these labels that are damaged or lost.

Additional Notes:

20. Do not attempt to remove a paper jam, no matter how minor it may appear to be, while the machine is running.
21. When cleaning the fold rolls, use the handwheel for turning. Be sure the power to the machine is off.
22. Turn off the machine before making any adjustments to the scoring, perforating, or slitting attachments. Keep hands and clothing away from the slitter shafts when the machine is running.

WARNING LABELS

WARNING GUARD MISSING
DO NOT OPERATE

50944

WARNING
GUARD MISSING
DO NOT OPERATE

50945

CAUTION – HAZARDOUS MOVING PARTS – GUARDS MUST BE IN PLACE WHEN OPERATING FOLDER – KEEP HANDS, HAIR & LOOSE ARTICLES AWAY FROM MOVING PARTS.

50215

CAUTION - HAZARDOUS MOVING PARTS
DO NOT OPERATE MACHINE
WITHOUT GUARD IN PLACE

40686



CAUTION
HIGH VOLTAGE
EXISTS WHEN
DOOR IS OPEN

REMOVE VOLTAGE
AT POWER SOURCE
BEFORE SERVICING

42877

CHANGE SPEEDS ONLY
WHEN FOLDER IS RUNNING

39379

INTRODUCTION OVERVIEW

The 1st station [parallel] folder with pile feeder contains the following main components (Figure 1):

1. Pile Feeder
2. Register
3. 1st Station Folder (Parallel)
4. Fold Roller Gapsets
5. Fold Plates
6. Slitter Shafts (not shown)
7. Delivery (Stacker)
8. Operator Controls
9. Double Sheet Detector (Caliper)
10. Vacuum Pump (not shown)
11. Handwheel

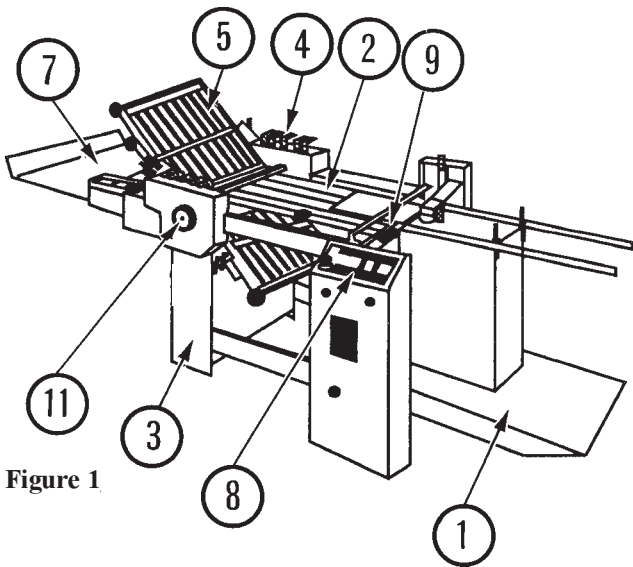

Figure 1

TRANSPORTATION/INSTALLATION

As soon as you receive your new folder, and before removing the machine from the skid, check carefully for any damage to the shipments. If any damage is found, promptly contact your Baumfolder sales representative.

To lift the folder from the skid, place the fork lift rails under the lower rails as shown in Figure 2. Note that the fork lift must have at least a 1500 lb. capacity.

Remove all rust protection coating after unpacking the folder.



Figure 2

Level the machine on the floor. Place a spirit level on the #2 fold roller (Figure 3) and on the feeder crossmembers.

SQUARING THE MACHINE

It is essential that this folding machine is square in order for it to work properly. To square the machine, measure diagonally across corners from feeder frame to folder frame (Figure 4). Dimensions shown are approximate. Be sure that the measurements taken are identical within 1/16-inch. If the machine is out of square, shift the frames in the direction needed until the proper squareness is obtained.

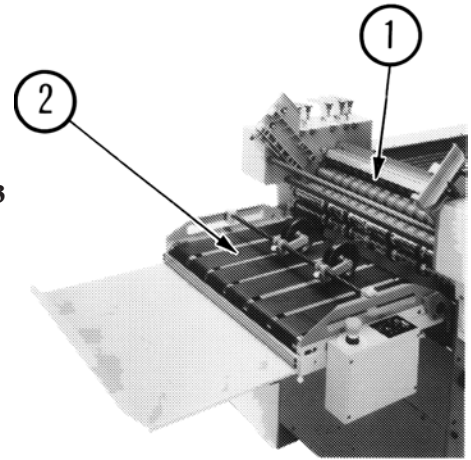

Figure 3

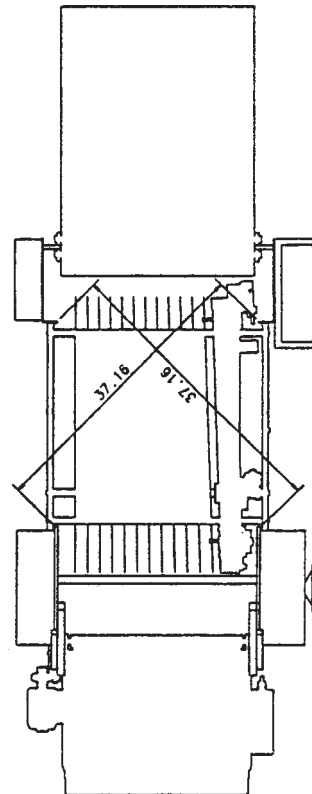

Figure 4

ELECTRICAL CONNECTIONS

1.0 Wiring the Pump (2018 / 1 phase)

Connect the pressure/vacuum pump at the pump junction box (Figure 5) using the attached cable. Follow the instructions below for the proper connections.

There are six wires from the control box to the pump. Wire #1 connects to the terminal marked 1 in the pump motor. Wire #2 connects to the terminal marked 4 in the pump motor. Wires #3, #4, #5 & #6 are not used and should be taped off separately. The green wire is the ground that is attached to the motor frame.

1.1 Other Connections

Refer to the serial number plate for electrical requirements. The serial number plate notes the voltage, phase and hertz, minimum time delay fuse, total machine amperage, and minimum wire conductor size for the main power connection.

The main power is connected directly to the line side of the main power switch. In a 2018 single phase use L1 and L2 only.

All electrical connections are to be made by a certified electrician. Refer to local building electrical codes for proper and safe connections.

For the following items, refer to Figure 6. Run a power cable from your distribution box to the main control box on the pile feeder. Turn the main power switch to zero. Using the appropriate tool, open the latches on the control box door and open the door.

NOTE: The door is connected to the main box by a ground wire that should not be removed.

1.2 Tapping the Transformer

Pass the power cable through the strain relief and the hole provided in the control box. Connect the power cable to the open terminals on the main disconnect in the control box. The incoming ground wire should be attached to the ground stud located in the lower right-hand corner of the control box.

To tap the transformer, read the incoming voltage at the main disconnect. Then move the wire numbered 11L1 on the transformer to the corresponding tap on the transformer.

Tighten all screw connections and close the door before switching the machine on.

A connector is provided for power connection to the stacker. The stacker must be plugged into the socket for the machine to operate, if not, install the blind plug attached to the box.

A connector is provided for power connection to the second station (8-page) fold unit. If no additional folding station is to be connected, the connector must be closed off with a blind plug.

1.3 Pump Connections

Connect the air hoses to the pump. The small diameter hose is connected to the vacuum side of the pump. Connect it to the barbed fitting above the ball valve on one end and the other end to the vacuum solenoid valve on the pile feeder.

Connect the larger diameter hose to the remaining outlet port on the pump and to the barbed fitting on the pile feeder at the end of the blow bar.

Troubleshooting tips and actions required for the display messages that may appear on the control readout may be found the "Diagnostic Messages" section of the manual.

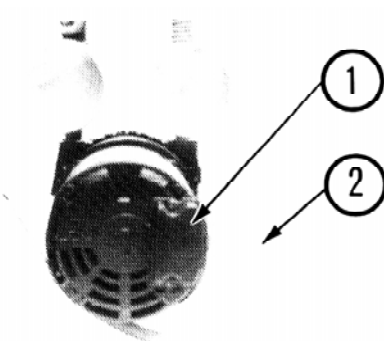

Figure 5

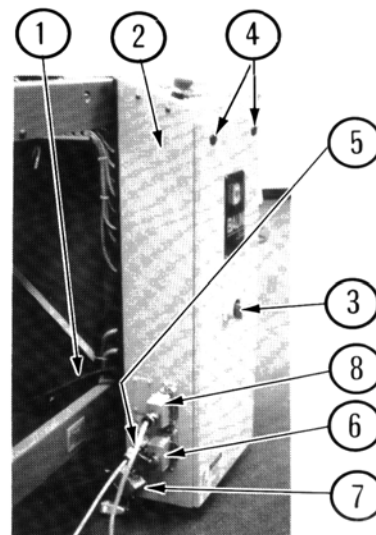

Figure 6

INSTALLING FOLD PLATES & STACKER DELIVERY

Install the fold plates into the folder. When installing the fold plates, take note of the symbol on the fold plate stop (Figure 7-1). The swing deflector may only be brought forward when the deflector symbol is also in the forward position. Lock the fold plates in position with the clamp levers (7-2). See "Fold Pan" section for fold plate setting procedure.

Attach the delivery stacker (3-2) by hooking the hanger brackets onto the round rods at the exit end of the folder. Plug the stacker power cable into the corresponding outlet on the main control enclosure on the pile feeder (Figure 6-1).

Pull the handwheel (Figure 1-11) to manually turn the fold rollers to be sure that they are operating smoothly. Check for any foreign material, and be sure that the deflectors do not touch the fold rollers.

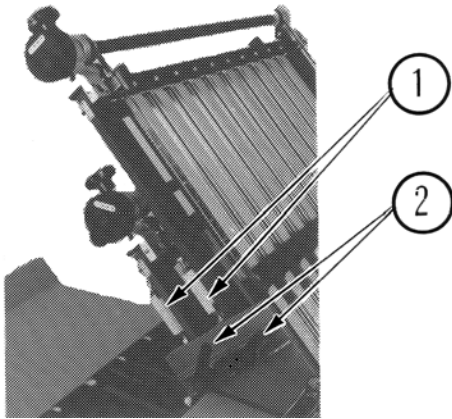

Figure 7

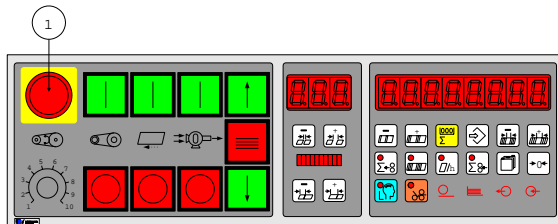

Figure 8

OPERATOR CONTROLS

The main operator control panel (Figure 8) is located at the pile feeder. See the "Control Panel" section for a detailed description of all the buttons.

1.0 Setting Folding Speed

The speed of the fold rollers may be set while the folder is running! This is done by adjusting the speed control potentiometer located on the top left side of the main control panel. Clockwise rotation speeds the folder up; counter-clockwise rotation slows the folder down.

1.1 Setting Stacker Belt Speed

An infinite speed range between high and low is set by turning the control knob (Figure 9-1).

1.2 Emergency Stop Button

When an emergency stop button (8-1 & 9-2) is pressed, the result is:

- Sheet feed - stop
- Folder drive - stop
- Pile lift - stop

The pressure/vacuum pump continues to operate. The emergency stop button must be pulled to release before the machine can be restarted. An error message "StoP" will appear on the readout.

The emergency stop buttons are found at the main operator control panel (8-1) and the delivery control (9-2).

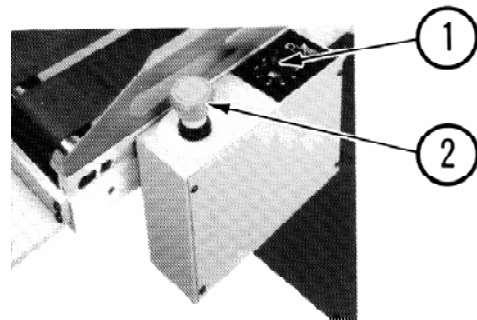

Figure 9

1.0 Control Panel BAN-5

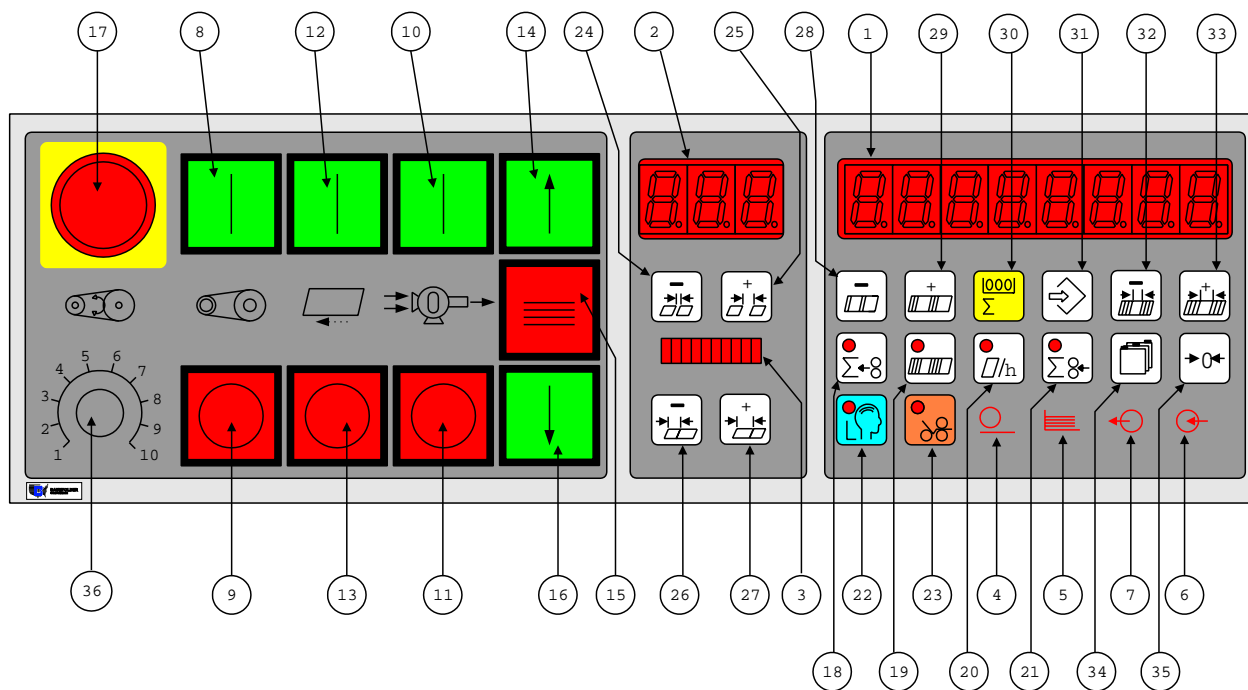

Figure 1. Control Panel.

1.1 Displays

- 01) Large Display
Eight digit multi use display composed of 7-segment LED's.
- 02) Small Display
Three digit multi use display composed of 7-segment LED's.
- 03) Ten segment bar graph display
The suction length display is used to display the Suction Length as a percentage of Sheet Length. This allows a range from 5% to 50%.

1.2 Machine Status Indicators

- 04) Suction Indicator
The suction indicator will track the suction output. The LED will turn on when the suction output turns on.
- 05) Pile indicator
The indicator is lit when the feeder is in automatic feed mode. The indicator will flash if the feeder is in reverse mode (Continuous Feeder) or moving down (Pile feeder)

- 06) Input Indicator
The input indicator shows the status of the suction photo-eye.
- 07) Output Indicator
The output indicator lights when the Batch Preset is reached and the user has selected a batching option. The output indicator is lit during the time the batching option is active. Batching options are Feed interruption, Speed up table, Marking table or Kicker.

1.3 Machine Control Pushbuttons

- 08) Main Drive Start
- 09) Main Drive Stop
- 10) Pump Start
- 11) Pump Stop
- 12) Feeder Start
- 13) Feeder Stop
- 14) Pile Feeder Up, Continuous Feeder Start
- 15) Pile Feeder Stop, Continuous Feeder Stop
- 16) Pile Feeder Down, Continuous Feeder Reverse
- 17) Emergency Stop

1.4 Keypad Buttons with Selection Indicators

- 18) Show Output Count
- 19) Show Batch Count and Number of Batches
- 20) Show Current Rate
- 21) Show Input Count
- 22) Learn Mode
- 23) Make Ready Mode

1.5 Keypad Buttons for Selection Adjustment

- 24) Gap Minus
- 25) Gap Plus
- 26) Suction Length Minus
- 27) Suction Length Plus
- 28) Batch Preset Minus
- 29) Batch Preset Plus
- 30) Counter Setup Mode
- 31) Machine Setup Mode
- 32) Batching Time Minus
- 33) Batching Time Plus
- 34) Network Job Mode
- 35) Reset
- 36) Potentiometer Speed adjustment

2.0 Run Mode Functions

After turning on the main switch, the control automatically runs a self test. During this self test all displays and indicator lights come on for approximately 4 seconds. After a successful self test, the display reverts to the previous count screen active before power shutdown. In this mode, various job parameters can be displayed on the large display (1) and the small display (2) shows the gap length. The suction length display (3) is active in this mode and shows the suction length as a percentage of sheet length.

The DCT500 mode select keys perform the same function in all modes, except Counter Setup. This allows a user to quickly switch between the operating modes on the counter. Select Make-Ready is not a mode unto itself, but rather is a modifier to all modes.



During the self test operation, do not press any button. Pressing of a button will cause an error message to appear in the main display.

2.1 Machine Setup/Diagnostic Mode



Pushing this key puts the controller in machine setup mode.

Machine setup mode provides a method to view and optionally change operating parameters for the controller. The decimal points in the large display (1) will move from side to side to indicate that various parameters may be changed. In this mode, the small display gives the selected parameter number, while the large display (1) shows a parameter value. The suction length display (3) is disabled.

Parameter Group Selection



The plus and minus keys are used to select the various parameter groups: machine setup parameters, machine monitor parameters, machine diagnostic parameters, knife status parameters, and machine usage parameters.

Parameter Selection within a Group



If the large display (1) decimal points are moving, this set of minus and plus buttons will select the machine parameters within each group, see tables 1-6.

Select Parameter Adjustment



If the large display (1) decimal points are moving, this set of minus and plus buttons will move through the set of values for the selected parameter, see tables 1-6.

2.1.1 Machine Setup Parameters

Parameter	Function	Type		Variable Displayed
P00	Input Factor	Setup Variables	Adjustable	1-24
P01	Output Factor	Setup Variables	Adjustable	1 to Input Factor
P02	Tremat	Setup Variables	Adjustable	1 or 0
P03	Knife	Setup Variables	Adjustable	1 or 0

Table 1. Machine Setup Parameter List

P00: Input Factor

Each sheet sensed by the Sheet count sensor is multiplied by the Factor number and added to the Total Input Count, but does not effect the Batch Down Count, Number of Batches or the Rate. The Factor can range from 1 to 24. If the Input Factor is changed, it also changes the value of the Output Factor to the same setting.

P01: Output Factor

This number is added to the Total Output Count but does not effect the Batch Down Count, Number of Batches and the Rate. The Factor can range from 1 to Input Factor setting.

P02: Tremat

This is an unavailable option.

P03: Knife

This is an unavailable option.

2.1.2 Machine Monitor Parameters

#	Function	Type	Variable	Displayed
P10	Machine Speed	Process Variable	Based on input	Meters/Minute
P11	Job Run Time	Process Variable	Based on input	Hours
P12	Job Stop Time	Process Variable	Based on input	Hours
P13	Job Make Ready Time	Process Variable	Based on input	Hours
P14	Pause Time	Process Variable	Based on input	Hours
P15	Job Number	Process Variable	Based on Input	Number 1 - 9999
P16	Employee's Number	Process Variable	Based on input	1 - 255

Table 2. Machine Monitor Parameter List

P10: Machine Speed (Velocity)

This selection shows the machine speed in meters/minute.

P11: Job Run Time

Displays the time duration this job has ran. Time displayed in .01 Hours. This information becomes part of the job record.

P12: Job Stop Time

Display the time duration this job has been interrupted. Time displayed in .01 Hours. This information becomes part of the job record.

P13: Job Make Ready Time

Displays the length of time that the Make Ready feature was enabled. Time displayed in .01 Hours. This information becomes part of the job record.

P14: Pause Time

Display the length of time that the Job was Paused. Time displayed in .01 Hours. This information becomes part of the job record.

P15: Job Number

A Job Number may be entered so that production data may be recorded against it. This is an operator entry. This information becomes part of the job record.

P16: Employee's Number

An Employee may be assigned a number. When the employee operates the machine, his number may be entered. This information becomes part of the job record.

2.1.3 Machine Setup Parameters

#	Function	Type	Variable	Displayed
P20	Units of Measure	Setup Variables	Adjustable	Inches, Meters
P21	Language	Setup Variables	Adjustable	English, German, Codes
P22	Network Address	Setup Variables	Adjustable	0-255
P23	Pause	Setup Variables	Adjustable	1 or 0
P24	Network	Setup Variables	Adjustable	1 or 0
P25	Easy	Setup Variables	Adjustable	1 or 0
P26	Software Version	Machine Configuration	Fixed	V X.X.X
P27	Machine Type	Machine Configuration	Fixed	Set at Factory
P28	Serial Output Type	Machine Configuration	Fixed	Off, Display, or Network

Table 3. Machine Setup Parameter List

P20: Units of Measurement

This selection specifies the unit of measurement used to display all lengths. Inches (SAE) is the default selection. Available choices are Meters (measurement displayed in cm) and Inches (measurement displayed in inches and tenths of inches).

P21: Language

This selection specifies the Language used to display fault messages. Available choices are ENGLISH, DEUTSCH, and CODES, see Tables 16–18, Error Message Translation. English is the default selection.

P22: Network Address

This selection specifies the unit address used for Network communication. Available choices are 0 through 255. Address 0 is the default selection. Network functions are not available in software version 2.6.0

P23: Pause

P24: Network Enable

Network components must be installed and enabled in Maintenance Mode. Enable Network by selecting “1”. Disable network by selecting “0”.

P25: Easy Mode

Enable Easy Mode by selecting “1”. Disable Easy Mode by selecting “0”.

Easy Mode has two sheet control methods, Easy setup or Continuous cycle. Easy setup will run any job with a 1 inch sheet gap. The sheet gap display contains 3 dashes and the Suction Length bar graph is turned off.

In Continuous cycle setup, the suction cycle is determined by the sheet gap setting, sheet length setting and the suction length setting. Sheet error detection methods are turned off.

P26: Hardware and Firmware Version

This selection shows the hardware and firmware versions of the unit. The left side of the display shows logic board type. The right side of the display shows the firmware version (2.X.X).

P27: Machine Type

This selection, in maintenance mode, shows the selected machine configuration.

P28: Serial Output Type

This selection, in maintenance mode, shows selected serial output type.

P28: Serial Output Type

This selection, in maintenance mode, shows selected serial output type.

2.1.4 Diagnostic Parameters

P30	Status Input Port 1							
	P30.1 Pile Motor Energized	P30.2 Function Control K1	P30.3 Pile Down Button	P30.4 Pile Stop Button	P30.5 Pile Up Button	P30.6 Compress. Stop Button	P30.7 Compress. Start Button	P30.8 Drive Start Relay K3
P31	Status Input Port 2							
	P31.1 Pile Sensor	P31.2 Double Sheet Fault	P31.3 Pile Bottom	P31.4 Sheet Start Button	P31.5 Sheet Stop Button	P31.6 Thermal Fault	P31.7 Wrong Sheet Fault	P31.8 Emerg.Stop Drive Stop Button
P32	Status Input Port 3							
	P32.1 Ergonomic Pile Load Eye	P32.2 Not used	P32.3 Not used	P32.4 Not used	P32.5 Not used	P32.6 Suction Controller Fail	P32.7 Delivery Count Input	P32.8 Photo eye Suction Wheel
P33	Status Input Port 4 (Extension Port)							
	P33.1 Not used	P33.2 Not used	P33.3 Not used	P33.4 Not used	P33.5 Not used	P33.6 Not used	P33.7 Not used	P33.8 Not used
P34	Status Output Port 1							
	P34.1 N Not used	P34.2 Not used	P34.3 Not used	P34.4 Not used	P34.5 Pile Down is active	P34.6 Pile up is active	P34.7 Release Drive Start	P34.8 Compress Start (K4)
P35	Status Output Port 2 (Extension Port)							
	P35.1 Not used	P35.2 Not used	P35.3 Not used	P35.4 Not used	P35.5 Not used	P35.6 Not used	P35.7 Not used	P35.8 Not used

Table 4. Machine Diagnostic Parameter List

P30: Input Port 1 Status

P31: Input Port 2 Status

P32: Input Port 3 Status

P33: Input Port 4 Status (Extension)

This selection shows the inputs status(see table4).

P34: Output Port 1 Status

P35: Output Port 2 (Extension)

This selection shows the outputs status (see table 4).

2.1.5 Future Features

#	Function	Type		Variable Displayed
P40	Last Knife Eye Time 1	Not used	Not used	Not used
P41	Last Knife Eye Time 2	Not used	Not used	Not used
P42	Last Knife Eye Time 3	Not used	Not used	Not used
P43	Strokes knife 1	Not used	Not used	Not used
P44	Strokes knife 2	Not used	Not used	Not used
P45	Strokes knife 3	Not used	Not used	Not used

Table 5. Future Features List

2.1.6 Machine Usage Status Parameters

#	Function	Type		Variable Displayed
P50	Power on time	Machine Status	Based on Inputs	Time in 1/100 Hours
P51	Machine run time	Machine Status	Based on Inputs	Time in 1/100 Hours
P52	Total Input Sheets	Machine Status	Based on Inputs	Number in 1000 Sheets

Table 6. Machine Usage Status Parameter List

P50: Power On Time

This selection shows the time in 1/100 hour during the main switch of the machine is on.

P51: Machine Run Time

This selection shows the time in 1/100 hour during the main drive contactor of the machine is on.

P52: Total Input Sheets

This selection shows the total input counts in 1000 sheets

Exit Machine Setup and Diagnostic Mode



Pressing any of these keys will cause the controller to change to a new mode.

2.2 Counter Setup Mode



Pushing this key puts the counter in counter setup mode.

Counter setup mode is used to prepare the controller to run a job. The large display (1) shows the batch preset on the left-hand side and the batching output time on the right hand side. The decimal points in the large display (1) will move from side to side to indicate that a parameter may be changed. The small display (2) shows the batching type. The suction length display (3) is active.

Change Batching Type

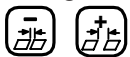

The minus and plus buttons move through a list of four output devices. The chosen Type is then activated when the batch down-count goes to zero. Feed interruption stops the feeding of sheets for the batching time setting.

The speed up-table output activates the marking table output for the batching time duration.

The MKE mode is an unavailable option.

The kicker is a future feature.

The output types are represented by animated symbols. The sequence of frames for the animations is shown in table 7.

	Feed Interruption	Speed Up Table	Not Available	Future Feature
Frame 1				
Frame 2				
Frame 3				
Frame 4				
Frame 5				
Frame 6				
Frame 7				
Frame 8				

Table 7. Output Type Animations

Batch Preset Adjustment



These buttons cause the batch preset value to increment or decrement. The preset will be reloaded after the user leaves the setup mode only if the value has been changed.

Batching Time Adjustment



The batching time adjustments allow the user to select the time duration associated with the currently selected output type. Two output types and times are available.

1. Feed interrupt has a range of 0.0 to 9.9 seconds.
2. Speed-up Table has a range of 0.00 to 5.00 seconds.

Select Count Source



The Output Count and Input Count keys select between count at delivery and feeder, respectively. One key LED will always be lit in Counter Setup to show the current count source, see table 8. Chasing LEDs will activate in the small display signifying the start setup mode. The next sheet fed through will be timed from leading edge to trailing edge and the delay time will be set to one half the sheet time. Please note this must be redone if the delivery speed is changed.

	The batching count source will be the feeder photoeye.
	The batching count source will be whatever is connected as the delivery photoeye.

Table 8. Count Source Selection

Exit Counter Setup Mode

Pressing any of these keys will cause the counter to change to a new mode.



2.3 Easy Mode and Continuous Cycle Mode

2.3.1 Easy Mode and Continuous Cycle Mode

Enable EASY mode at parameter P25, see Table 3.

Select Easy Mode



Pressing this button enables the selection of either the EASY mode or cYcL mode.



Pressing these buttons will toggle between the EASY mode or cYcL mode. Set EASY in the large display and press again.

Select Continuous Cycle Mode



Pressing this button enables the selection of either the EASY mode or cYcL mode



Pressing these buttons will toggle between the EASY mode or cYcL mode. Set cYcL in the large display and .press again.

Exit Run Mode



Pressing any of these keys will cause the counter to change to a new mode.

2.4 Learn Mode



This key places the controller in learn mode. Learn mode can only be activated if the folder is idle.

The learn mode allows the user to setup the suction valve controller. Both manual and automatic setup is accomplished in this mode. The large display (1) shows two separate data items. The suction mode is shown on the left and the sheet length is shown on the right. The small display (2) shows the current gap length. The suction length display is active. During Learn Mode, the Learn Mode key LED indicates whether a valid sheet has been learned.

	No valid sheet has been read yet, the system is in Single Sheet mode.
	A valid sheet has been read and the Job has been setup to run. Single Sheet mode is off.

Table 9. Learn Mode Status

When the LED is on, pushing the sheet start button will feed a single sheet of paper. If the sheet is fed properly, the indicator LED will go off. The suction mode will be set to automatic. The length of the sheet will be set as the current sheet length. The suction length will be set based on table 11 and the gap length will be set to 4 cm /1.50 inches.

If P06 is set to 0 (no knife is active) and 10 cm /4.0 inches.
 If P06 is setting to 1, knives are active.

Gap Length Adjustment



The minus and plus keys adjust the gap length. The gap length range is 0.2” to 98.0” (0.5cm to 250cm).

Suction Length Adjustment



This is the same as in run mode

The suction length adjustment keys allow the user to change the amount of suction applied to the current sheet length. The display shows the percentage in 5% steps. All of the bars must be totaled to get the value. The range of adjustment is 5% to 50% of the current sheet length. If the suction length is manually adjusted while the Learn Mode LED is on, the suction length will no longer be the Single Sheet suction length of 6.0”. The new suction length will be based on the current sheet length and suction setting.

	TWT-180 Mode
	Leading Edge Control
	Leading and Trailing Edge Control

Table 10. Suction Mode Symbols

Sheet Length Setting	Resultant Suction Length Percentage
Greater than or equal to 30 cm.	30% of Sheet Length
Less than 30 cm., and greater than or equal to 27 cm.	25% of Sheet Length
Less than 27 cm., and greater than or equal to 24 cm.	20% of Sheet Length
Less than 24 cm., and greater than or equal to 21 cm.	15% of Sheet Length
Less than 21 cm.	10% of Sheet Length.

Table 11. Suction Length Function

Exit Learn Mode



Pressing any of these keys will cause the controller to change to a new mode.

Select Suction Mode



These keys toggle between automatic control and cycle mode. In the cycle mode, the suction valve will be on for the suction length and off for the remainder of the sheet length plus the gap length. No adjustments are made for slipped sheets or process changes. The automatic mode corrects for process changes and controls the timing of the suction valve to maintain the user-selected gap. If the gap is less than 1.5” (4.0 cm), the right hand decimal point of the small display (2) will flash and the Leading edge control will be active. If the gap is greater than or equal to 1.5” (4.0 cm), full Leading and Trailing edge control is maintained. Refer to table 10 for suction mode symbol definitions.

Sheet Length Adjustment



The sheet length adjustment keys allow the user to override the automatic Learn Mode setting. When the user changes the sheet length, the suction length will be adjusted according to table 11. If a different suction length is desired, the value may be overridden with the suction length adjustment keys. The sheet length range is 10 cm /4 inches to 250 cm / 98.5 inches.

2.5 Make Ready Mode



This key places the controller in the make ready mode. The key LED goes on. In this mode the folder will only feed single sheets and a batching output is issued for every two sheets fed. This allows the operator to easily set up the batching time.

Exit Make Ready Mode



Pressing any of these keys will cause the controller to change to a new mode.

2.6 Network Job Mode



Pushing this key puts the counter in network job mode



This mode is only available if a STA-NET adapter is installed and activated through maintenance mode. In this mode the small display (2) always shows the word 'Job'. The large display (1) shows either 'PAUSE' or a job number which can be read from the network. The suction length display is disabled.

Select Job Number



This set of plus and minus keys step the large display (1) through pause mode and a list of available job numbers. While in network job mode, the folder is considered to be paused.

Load Job and Return to Run Mode



When this button is pushed the selected job will be loaded into the counter and the counter will return to run mode. If the large display (1) was showing the message 'PAUSE', the network job mode will end, but no job will be loaded.

Exit Network Job Mode



Pressing any of these keys will cause the counter to change to a new mode.

2.7 Production Mode

Enter Run Mode and Select Large Display Content



These keys do not operate as mode select keys in counter setup. In all other modes, the keys both select the large display (1) contents and place the counter into run mode. Pushing one of the buttons will light the button's associated LED and cause the parameter to be displayed. If both the input and output count keys are pressed simultaneously, then both LEDs go on and the waste count is displayed. See Process Variable Definitions.

Large Display Contents				
				Output Count
				Batch Count Down Number of Batches
				Current Rate
				Input Count
				Waste Count

Table 12. Determining the Large Display Contents



When the folder is started the counter will start up in the run mode, the normal operating mode of the counter. In this mode, various job parameters can be displayed on the large display (1) and the small display (2) shows the gap length. The suction length display (3) is active in this mode and shows the suction length as a percentage of sheet length.

Gap Length Adjustment



The gap length adjustment keys allow the user to change the current gap length. The range of adjustment is 0.2" to 98.0" (0.5 cm to 250 cm).

Suction Length Adjustment



The suction length adjustment keys allow the user to change the amount of suction applied to the current sheet length. The display shows the percentage in 5% steps. All of the bars must be totaled to get the value. The range of adjustment is 5% to 50% of the current sheet length.

Reset Function



Pressing and holding this key will result in a reset function being activated after a 5-second countdown. The function is based on the current large display selection, see table 12. The large display (1) will show countdown to reset in this manner. When the button is pressed the message 'CLr In 5' will show on the large display (1). At one second intervals the display will progress through 'CLr In 4', 'CLr In 3', 'CLr In 2', 'CLr In 1', and finally will show 'CLEARed' when the reset action is complete.



	Reset while showing Output Count will reset all job variables.
	Reset while showing batch data will reset Number of Batches and reload the Batch Down Count.

Table 13. Reset mode Selection

3.0 Logic Board Status Indicators

Several of the controller functions are monitored with LED indicators located on the Logic Board (see Table 14). The status of all other inputs are shown on the 8 Digit display in Machine Setup mode (see Tables 1 - 6).

Reference Designator	Name	Description
LED1	Tachometer Indicator	Tracks the Tachometer input.
LED2	Not Used	
LED3	Suction Indicator	Tracks the Suction output.
LED4	K1	Status of Relay K1
LED5	Pile Down	Tracks the Pile down output.
LED6	Pile Up	Tracks the Pile up output.
LED7	Pile Indicator	Tracks the Pile outputs. If one of the Pile outputs is on, this LED will be on.
LED8	Logic +5VDC Supply	Shows status of Logic +5VDC Supply
LED9	Isolated +5VDC Supply	Shows status of Isolated +5VDC Supply
LED10	Isolated +24VDC Supply	Shows status of Isolated +24VDC Supply
LED11	Kicker	Turns on when kicker output is activated.

Table 14. LED Status Indicators

4.0 Process Variables Definitions

4.1 Total Input Count

Total Input Count increments by the factor setting each time an input is received at the Input Count input. Total Input Count can range from 0 to 99,999,999. This process variable is stored in memory in case of a power outage. Reset job will clear this process variable to zero.

4.2 Total Output Count

Total Output Count increments by the factor setting each time an input is received at the Output Count input. Total Output Count can range from 0 to 99,999,999. This process variable is stored in memory in case of a power outage. Reset job will clear this process variable to zero.

4.3 Batch Down Count

The Batch Down Count is the number of remaining inputs necessary to trigger a batch output. As input counts are received, this value counts down to zero. Each input decrements the Batch Count Down by one. When zero is reached, the Batch Down Count resets to the Batch Preset. The Count input that is used by the Batch Down Count is determined by the Batching Selection in Machine Setup. If Feeder is the Batching Selection, the Batch Down Count will be affected by the Input Count Input. If Delivery is the Batching Selection, the Batch Down Count will be affected by the Output Count Input. Batch Down Count can range from 1 to 999. This process variable is stored in memory in case of a power outage. Reset job will clear this process variable to zero. Reset batch will load this process variable with the batch preset.

4.4 Number of Batches

The Number of Batches is the number of times the Batch Down Count has reached zero. Number of Batches can range from 0 to 9999. This process variable is stored in memory in case of a power outage. Reset job will clear this process variable to zero. Reset batch will clear this process variable to zero.

4.5 Current Rate

The Current Rate is based on the number of Input Count inputs received during the sample period. The Current Rate is calculated every second. The Current Rate is shown as rate per hour

The Current Rate is rounded to the nearest hundreds. Current Rate can range from 0 to 99,999,900. This process variable is not stored in memory.

4.6 Main Drive Run Time

The Main Drive Run Time is the amount of time the Drive output has been on since the last Clear All Memory Reset in Maintenance Mode. This value is displayed in the format HHHHHH.HH. Main Drive Run Time can range from 0.00 to 999,999.99. This process variable is stored in memory in case of a power outage. Reset ALL in maintenance mode will clear this process variable to zero.

4.7 Main Drive Velocity

The Main Drive Velocity is the speed of the Tachometer input. This value is displayed in meters per minute. This value is calculated every 300 milliseconds. This process variable is not stored in memory.

4.8 Waste Count (Option)

The Waste Count is the difference between the Total Input Count and the Total Output Count. Waste Count is accessible by pressing and holding the Total Count button followed by pressing the Total Output Count button. Waste Count can range from 0 to 99,999,999. This process variable is not stored in memory. Reset job will clear this process variable to zero.

5.0 Counter Setup Variables

5.1 Batch Preset

This parameter, accessible in the Batch Setup mode, specifies the batch count that will be used by the Batch Count Down. Zero is the default setting. This value can range from 0 to 999.

5.2 Batch Output Type

This parameter, accessible in the Batch Setup mode, specifies the batch output type that will be used when the Batch Count Down reaches zero. Available choices are Feed (FED), Delivery (DEL), Speed (SPD), and Table (TBL).

5.3 Batch Output Time

This parameter, accessible in the Batch Setup mode, specifies the output duration or delay that will be used when the Batch Count Down reaches zero.

Available ranges are determined by the Batch Output Type selected. The Table below shows the ranges for each output type.

Output Type	Delay		Duration	
	Min. Time	Max. Time	Min. Time	Max. Time
Feed	Not applicable		0.0 Sec.	9.9 Sec.
Table	0.000 Sec.	1.000 Sec.	100 ms	
Delivery	0.000 Sec.	1.000 Sec.	25 ms	
Speed	Not applicable		0.00 Sec.	5.55 Sec.

Table 15. Output Delay and Duration

5.4 Sheet Length

This parameter, accessible in the Batch Setup mode, specifies the length of the paper that will be fed into the machine.

Available range is 6.0” to 59.0”. 6.0” is the default selection.

5.5 Gap Length

This parameter is accessible in Run mode and Learn mode and specifies the length of gap to use between sheets of paper that are fed into the machine.

Available range is 0.2” to 98.0”. 2.0” is the default selection.

5.6 Suction Length

This parameter is accessible in Run mode and Learn mode and specifies the suction length used on a sheet of paper that is fed into the machine.

Available range is 5% to 50% in 5% increments. 30% is the default.

6.0 System Messages and Run Messages

6.1 Power-Up Fault Messages

Messages that are displayed during power on self-test. If PLC System Errors are shown in the display, call service.

ENGLISH	GERMAN	CODES	TYPE	DESCRIPTION
88888	88888	88888	Information	The controller is performing its lamp test.
MEM TEST	MEM TEST	MEM TEST	Information	The controller is performing its RAM test.
All Blank	All Blank	All Blank	PLC System Error	The display board is not functioning. Cycle Power. If error persists, call service.
ID Fail	ID Fail	ID Fail	PLC System Error	System cannot recognize the controller board. <i>Action:</i> Cycle Power, if error persists call service.
Error 1	Error 1	Error 1	PLC System Error	The RAM test has found a bad memory location. <i>Action:</i> Cycle Power, if error persists call service.
Error 2	Error 2	Error 2	PLC System Error	The Pile Safety Relay is stuck on or there is no power supply to the pile circuits. <i>Action:</i> Check the condition of Relay 1 (K1), Fuses F1 and F2, and X18. Cycle Power. If error persists, call service.
Error 3	Error 3	Error 3	PLC System Error	There is power in the Pile Drive when it is off. <i>Action:</i> Check the condition of Relay 1 (K1), Fuses F1 and F2, and X18. Cycle Power. If error persists, call service.
Error 4	Error 4	Error 4	PLC System Error	The 24VAC inputs have current before the Watchdog relay has been activated. <i>Action:</i> Check for stuck push buttons, faulty sensors, or loose connectors. Cycle Power. If error persists, call service.
Error 5	Error 5	Error 5	PLC System Error	The membrane switch panel has a key pressed during the power on self-test. <i>Action:</i> Cycle Power, if error persists call service.
Error 6	Error 6	Error 6	PLC System Error	The Watchdog sense circuit indicates Watchdog-timer operational before it has been started. <i>Action:</i> Cycle Power, if error persists call service.

Table 16. Power Up Fault Messages

6.2 Run Time Fault Messages

Run time fault messages are only displayed when the unit is in Run mode. Fault errors can still occur, but the corresponding fault message will not be displayed until the unit is switched to Run mode. Run time fault messages are PLC System Errors or errors in the whole Electric System. It is necessary to call a technician or service.

ENGLISH	GERMAN	CODES	TYPE	DESCRIPTION
DCT X.X.X	DCT X.X.X	DCT X.X.X	Information	This is the Software-Version(X.X.X) Note: do not push any buttons until this message has been cleared from the display
K5 Relay	K5 Relay	Error 7	PLC System Error	The drive stop relay, K5, is not responding to the controller. <i>Action:</i> Call service.
Button	Taste	Error 8	Electrical System Error	A push button is in the wrong state during the version message display. <i>Action:</i> Check Buttons & Cycle Power. If error persists call service.
Watchdog	Watchdog	Error 9	PLC System Error	The Watchdog Timer has elapsed without being serviced. <i>Action:</i> Cycle Power. If error persists call service.
No Tach	Impuls	Error10	Electrical System Error	The Machine Tachometer is reading a velocity outside of the range 10 – 230 meters per minute, while the main drive should be running. <i>Action:</i> Check the electric. If error persists call service.
Overload	Überlast	Error11	Electrical System Error	A Thermal Overload has been tripped. <i>Action:</i> Check the electric. If error persists call service.
Pile Err	Spg.Uber	Error12	Electrical System Error	The Pile Safety Relay is stuck on or there is no power supply to the pile circuits. <i>Action:</i> Check the condition of Relay 1 (K1), Fuses F1 and F2, and X18, then cycle Power. If error persists call service.
Overrun	Überlauf	Error13	Electrical System Error	The Pile Table has moved past its safety stops. <i>Action:</i> Check the limit switches, pile table, and wiring. If error persists call service.
2 nd Stat	2Station	Error14	Electrical System Error	The Emergency Stop, Wrong Sheet, and Thermal Overload sense circuits are all indicating failure. Likely cause is Second Station connector problems. <i>Action:</i> Check the Second Station Connector, connector X22, and each individual circuit. If error persists call service.
Suction	Saugtakt	Error15	Electrical System Error	Short circuit on Suction controller. <i>Action:</i> Check the electrics. If error persists call service.

Table 17. Run Time Fault Messages

6.3 Machine Run Error Messages

Machine Run Error Messages help the operator to indicate a production problem.

ENGLISH	GERMAN	CODES	TYPE	DESCRIPTION
Stop	Stop1	Stop1	Information	One of the stop buttons is depressed. <i>ACTION</i> : Make sure all stop buttons are cleared and connectors X21, and X22 are seated.
Wrng Sht	Fehlerbg	Stop2	Machine Run Error	The Wrong Sheet Detector has been tripped. <i>ACTION</i> : Clear the fault. <i>NOTE</i> : If the main drive was running, the error condition will remain latched until the Drive START is pressed.
2 Sheet	Doppelbg	Stop3	Machine Run Error	The Double Sheet Detector has been tripped. <i>ACTION</i> : Clear the fault and check X22. <i>NOTE</i> : If sheet feed was active, the error condition will remain latched until the Sheet Start is pressed.
No Feed	Bog.Fehl	Stop4	Machine Run Error	No paper detected within 40 cm of suction valve actuation, while running in an automatic feed mode. <i>ACTION</i> : Check misfeed, connector X14, and the condition of the count photo-eye.
Feeder	Sensor	Stop5	Machine Run Error	Photo-eye at suction valve is covered before Sheet Start is active.
Long Sht	Bg.Lang	Stop6	Machine Run Error	The count photo-eye has been covered for more than 150% of the user set sheet length distance. <i>ACTION</i> : Check misfeed, connector X14, and the condition of the count eye.
Knife 1	Schwert1	Stop7	Machine Run Error	The knife input 1 has been active for more than 1.5 times the last measured time. <i>ACTION</i> : Clear the fault.
Knife 2	Schwert2	Stop 8	Machine Run Error	The knife input 2 has been active for more than 1.5 times the last measured time. <i>ACTION</i> : Clear the fault.
Knife 3	Schwert3	Stop 9	Machine Run Error	The knife input 3 has been active for more than 1.5 times the last measured time. <i>ACTION</i> : Clear the fault.
Snsor DN	Stpl Ab	Stop 10	Machine Run Error	The Pile has been moving down for more than 2.5 seconds while the unit is feeding paper. <i>ACTION</i> : Check Pile Sensor.
Snsor Up	Stpl Auf	Stop 11	Machine Run Error	The Pile has been moving up for more than 1.5 seconds while the unit is feeding paper. <i>ACTION</i> : Check Pile Sensor.

Table 18. Machine Run Error Messages

PILE FEEDER OPERATION

1.0 Loading the Pile Feeder

Set the right hand side guide (Figure 11-1) to half the sheet using the scale (11-2). The vacuum wheel is in the center of the sheet. Lock the guide in place using the lever (11-3).

Remove the left hand guide (Figure 12-4) from the feeder. Move the sheet drag guide block (12-5) on the right-hand guide to the rear of the paper stock.

Press the table down button (for controls, see page 8). A lower limit switch will halt the pile table when it descends to the lowest position. Load the paper against the front and right hand guides (11-1).

Press the table up button. The pile height sensor (11-6) will stop the upward travel of the table. During operation, the top sheet of the pile should be approximately 1/2" under the vacuum wheel and 5/8" under the sensor (11-6), with the pile up and the pump off. The pile height sensor is contact-free.

Reinstall the left hand guide (12-4). Slide the register guide (12-7) inward until the see-through left hand guide (12-4) is approximately 1/16" away from the stack.

1.2 Hold-down Locations

Set the sheet hold-downs so the rubber bumpers rest on top of the sheet pile and prevent double sheets from being pulled in. Using the rubber bumpers is dependent upon the stock being fed.

1.3 Air and Vacuum Settings

Press the pile up button if it has not been pressed.

Press the pump "on" button.

Adjust the air flow into the top of the stack as shown in Figure 13, using the blow tube angle levers (Figure 14-1) and the air bleed off valve cover (14-2).

Figure 13 shows that the top four to five sheets are to be separated using the top blow tube (13-1). The bottom blow tube (13-2) separates approximately 1/2" of the stack under the top four or five sheets. The bottom blow tube (13-2) provides separation to send sheets up to the top to be fed.

Do not adjust the air angle flow too high into the sheets. The top sheets should be in a humped pattern as seen through the side guide for approximately 75% of the sheet length.

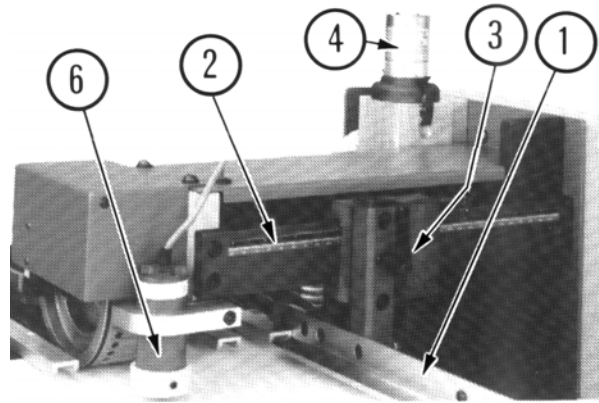

Figure 11

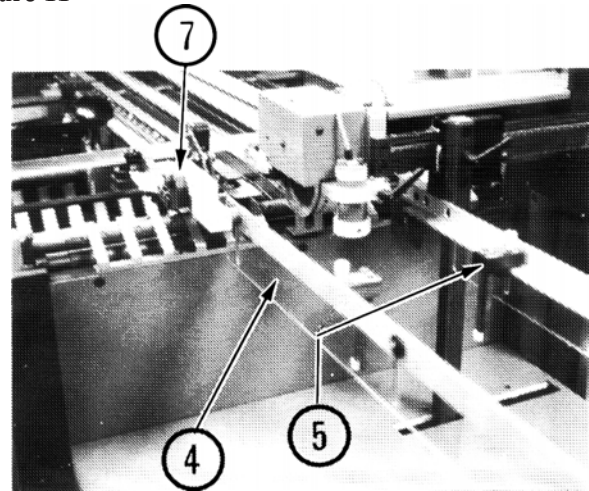

Figure 12

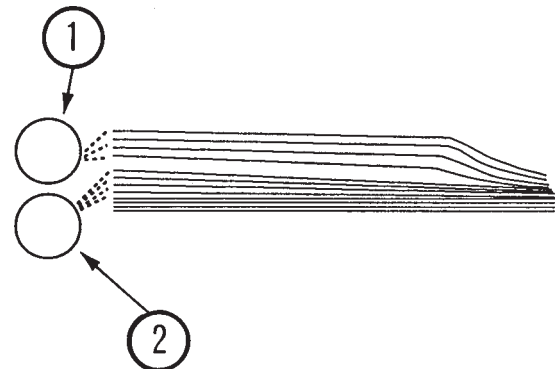

Figure 13

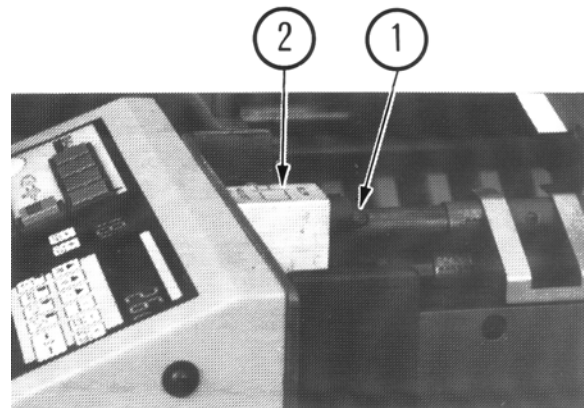

Figure 14

1.3 FRONT BLOW TUBE SETTINGS

The front blow consists of two tubes (Figure 13-1 & 2 and Figure 15-1 & 2) instead of the traditional one tube. The numbers on the left hand side of the tubes correspond to the chart (Figure 15-3) found on the side of the main control enclosure.

Setting Up

- 1.) Determine the width of the job to be run.
- 2.) Find the numbers on the right-hand side of chart that correspond with the sheet width.
- 3.) Set the top (15-1) and bottom (15-2) blow tubes, using the detent slots, to the respective numbers.

Vacuum adjustment is made at the pump (Figure 16) using the valve (16-1). Vacuum adjustment requirements should be minimal. Listen to the feeding at the vacuum wheel to determine if there is too much vacuum. The vacuum valve (16-1) should be set as shown for most applications.

1.4 Vacuum Wheel

The vacuum flow is controlled by a solenoid valve (Figure 11-4 & 17-1). This can be quickly and easily removed to clean the piston (17-2) by releasing the clamping springs. Be careful not to damage the piston and cylinder.

The vacuum wheel (Figure 18-1) is supplied with two O-rings (18-2) to assist feeding with a positive friction grip. These O-rings are replaced after removing the guard (18-3) by removing the two button head screws (18-4) holding it.

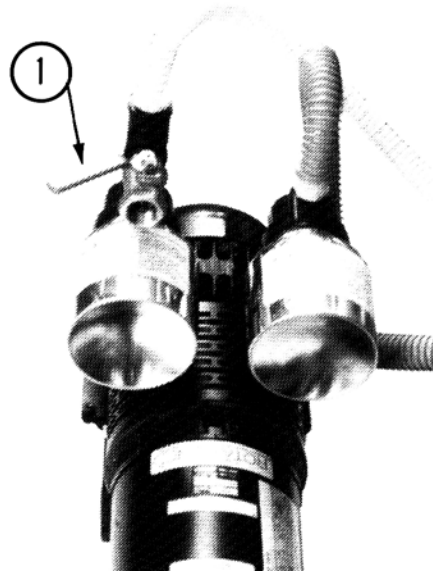

Figure 16

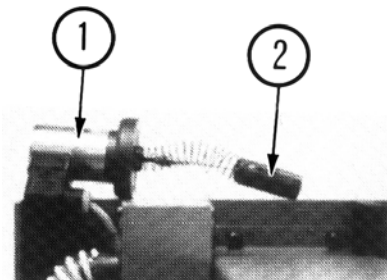
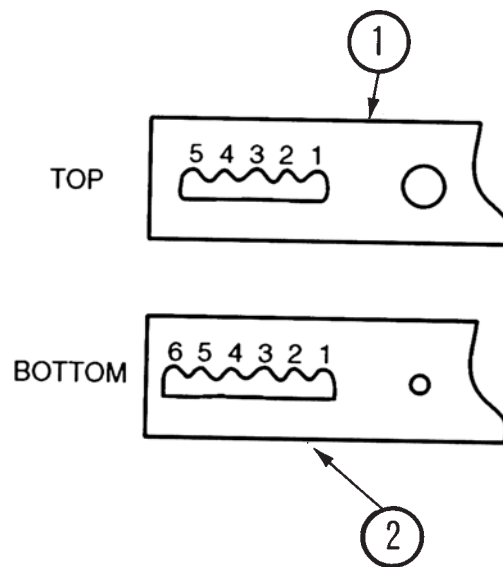

Figure 17

FRONT BLOW SETTINGS			
SHEET WIDTH		BLOW TUBE	
ENGLISH	METRIC	TOP	BOTTOM
4" TO 6"	102 TO 152	1	1
6" TO 9"	152 TO 230	1	2
9" TO 12"	230 TO 305	2	3
12" TO 15"	305 TO 380	3	4
15" TO 18"	380 TO 460	4	5
18" TO 21"	460 TO 530	5	6



Figure 15



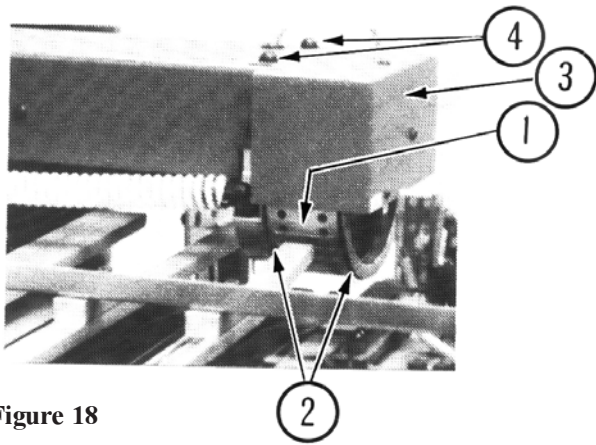

Figure 18

REGISTER OPERATION

Use the fluted knob (Figure 19-1) to slide the side guide (19-2) with the marble holder (19-3) to the required location 1/16" away from the pile stack.

Move the sheet support (19-4) to the right hand side of the sheet.

Place the steel and/or plastic marbles into the marble holder (19-3). It is recommended to have at least two steel marbles in the first four to six positions closest to the pile feeder end.

The succeeding positions can be filled with steel or plastic marbles depending on the stiffness of the paper. For registering oblong sheets it is recommended to have at least 50% steel and 50% plastic marbles alternating in the marble holder.

Clip-on sheet hold-downs (19-5) placed across the register table prevent the sheets from rising. The hold-down with the angle-formed end is to be placed in front of the vacuum wheel.

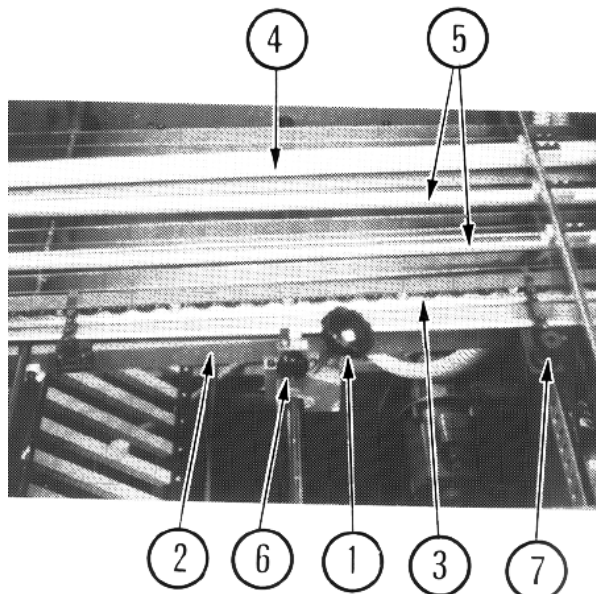

Figure 19

The fluted knob (19-6) provides microadjustment of the side guide (19-2). Knurled knobs (19-7) provide bias adjustment for the side guide for adjusting sheets that are not square or for other unusual conditions.

The double sheet control (Figure 20) is adjusted to the thickness of the paper being fed by pulling up the lever (20-1) and inserting two paper strips (20-2) of the sheets to be folded in the clip at the back of the lever.

The feeler segment remains inoperative when a single sheet is passing through. When double sheets are being fed through, the feeler segment is pulled against a microswitch and the double sheet is stopped. Sheet feeding is stopped and the message "2 sheet" appears on the counter readout. The message remains until the double sheet is removed. Raise the lever (20-1) to remove the double sheet.

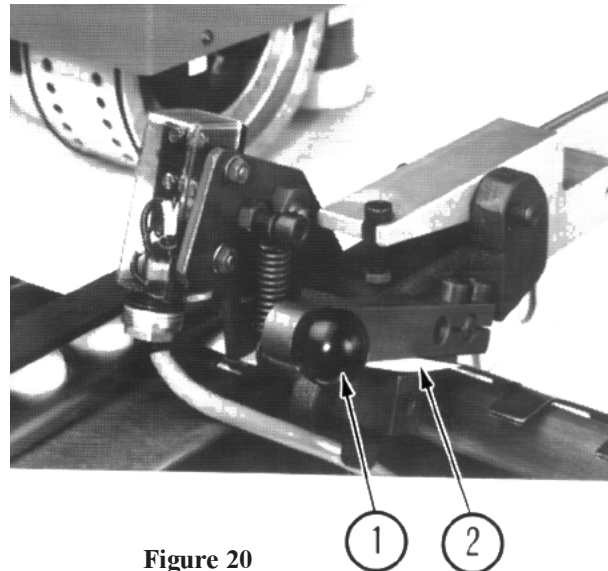

Figure 20

1.0 DOUBLE SHEET DETECTOR

The double sheet detector consists of a scanner element, microswitch and a free-wheel roller.

If the setting for paper thickness is exceeded, the scanner element trips the microswitch, closing the magnetic valve for the suction cycle so that sheet transfer is stopped instantaneously. While the double sheet is stopped, the sheets that are in the machine continue to be folded.

The double sheet stop must be set so that the scanner probe remains untouched when a single sheet of paper passes through. When two or more sheets are detected, it must trigger the stop mechanism. (See Figure 21)

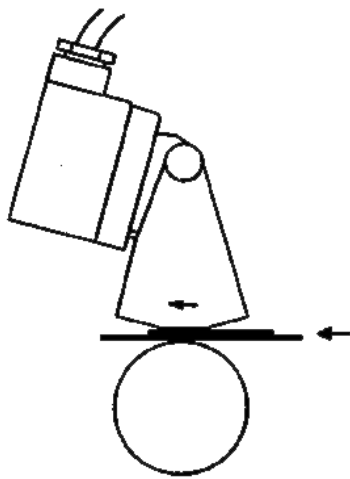

A double sheet strikes the scanner on the microswitch, interrupting the sheet flow-through.

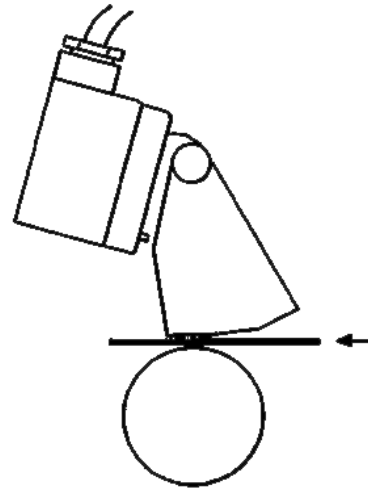

With single sheet thickness, the scanner remains untouched and sheets move freely.

Figure 21

BAUMSET ADJUSTMENT

1.0 Adjustment of Folding Rollers

Folding accuracy is determined largely by precise adjustment of the folding rollers.

Using the Baumset precision adjustment device, the correct setting of the rollers can be made simply by inserting the appropriate paper thickness between the adjustment plates. (See Figure 22)

With multiple thicknesses, insert single strips of the paper being folded equal to the number of sheets passing through that roller combination..

Since the adjustment spindle acts directly on the folding rollers, clearance settings are exact.

Another method for setting the folding rollers is to insert paper strips between them by touch, the pressure adjustment being made by turning the knurled screw.

The numbers on the Baumset adjustment knobs correspond to the buckle-plate numbers into which the sheet is fed. All upper buckle plates have odd numbers while the plates below are even.

The Baumset adjustment device is correctly zeroed at the factory. If any adjustment is necessary, strips of single paper thickness should be placed under every adjustment plate. The folding rollers are then reset by drawing strips of uniform thickness through the appropriate pair of rollers as far as possible to the other side.

At the same time, the knurled screws are adjusted so that the strips can be withdrawn when medium drag is felt. When this operation is complete, the dial rings are reset to zero.

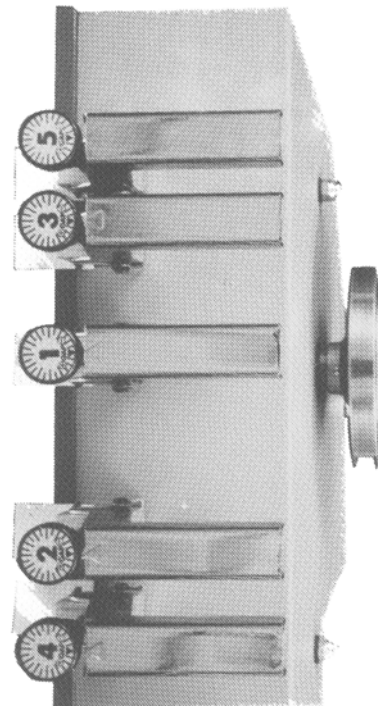

Figure 22

SETTING OF FOLD PLATES

NOTE:

Check the symbols on the fold plate stop (Figure 23-1) for installation of the fold plate swing deflectors (Figure 24-1) to avoid damaging the fold rollers. The deflector must only be brought forward when the stop (23-1) with the deflector symbol is in the forward position.

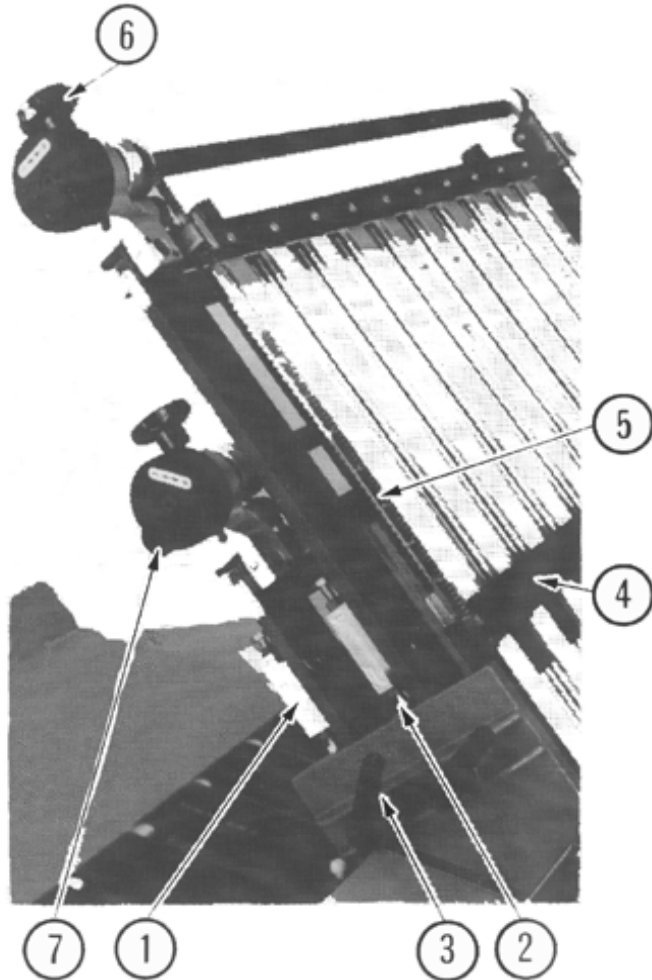

Figure 23

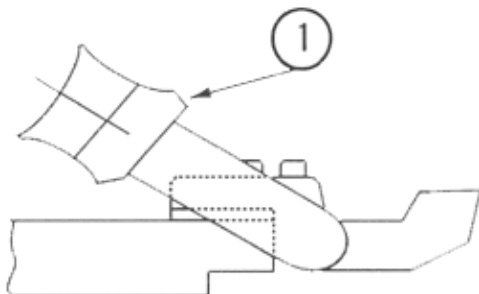

Figure 24

Be sure that the adjustment screw (23-2) is in contact with the support rail on both sides.

Clamp the fold plates with the clamping screw (Figure 23-3).

The sheet-stop (23-4) should be moved to the desired fold length according to the scale (23-5) by loosening the clamping screw (23-6) and then turning the adjustment wheel (23-7).

The sheet stop can be set at an angle for sheets that are not cut square by loosening the clamping screw (23-6) and turning the front adjustment wheel. The clamping screw (23-3) must be tightened for this adjustment.

For the fitting of a fold plate, both sides of the stop (23-1) must have the fold plate symbol turned to the front so that the adjustment screw contacts the support rail.

Equal adjustments at both ends are needed to prevent oblique folds or perforations.

CAUTION:

If the buckle space is reduced, be sure that the fold plate does not rub against the folding rollers. If this occurs, the rollers will be damaged. Check for rubbing by turning the handwheel on the folder before turning the power on.

SETTING OF SHEET DEFLECTORS

Fold plates that are not required for folding can be closed off with swing deflectors fitted in the infeed. The fold plate is slightly withdrawn and the deflector (Figure 25-1) is swung down and pushed in until it engages.

CAUTION:

Move stop (Figure 26-1) on both sides to avoid damage to the folding rollers. Loosen the knurled screw (26-2). Turn the stop and retighten the knurled screws. The deflector symbol (26-3) must be in forward position.

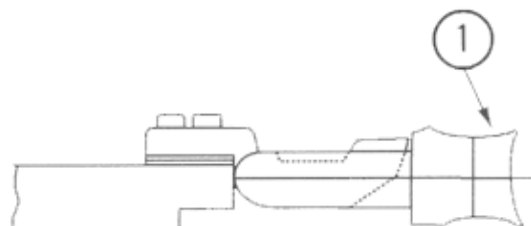

Figure 25

Check that the adjustment screws (26-4) are in contact with the support rail (26-5) on both sides.

The basic position is marked by a notch (26-6) in the fold-plate frame.

Setting Stationary Deflector

(Separate sheet deflector) (Figure 27-1)

The stationary sheet deflectors are installed and clamped in place in the same way as the fold plates.

NOTE:

The fold plates in an 8-page folder will work in the #4 fold plate position when four plates are desired. This applies to folders equipped with three fold plates and one stationary deflector.

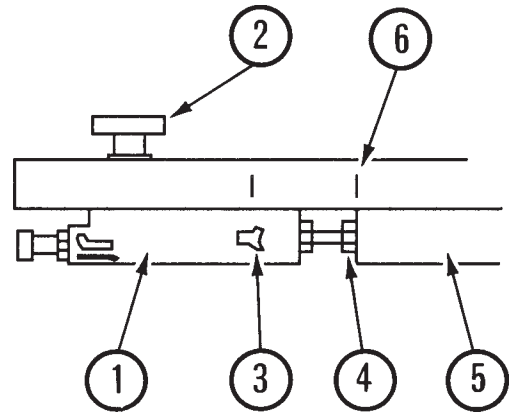

Figure 26

STACKER (DELIVERY)

The motorized hang-on stacker has the following unique features.

- Independent speed adjustment by using the speed selector (Figure 28-1).
- Telescoping delivery tray that is fixed in position using thumbscrews (28-2) below the tray.
- Nosebar with brush (28-3) that prevents sheets from becoming trapped and eliminating a pinch point.
- The stacker can be mounted level or at an angle to assist stacking of sheets that tend to spring open.

The stacker electrical power source is provided by inserting the male receptacle on the stacker power cord into the mating connector found on the left hand side on the main electrical enclosure of the pile feeder.

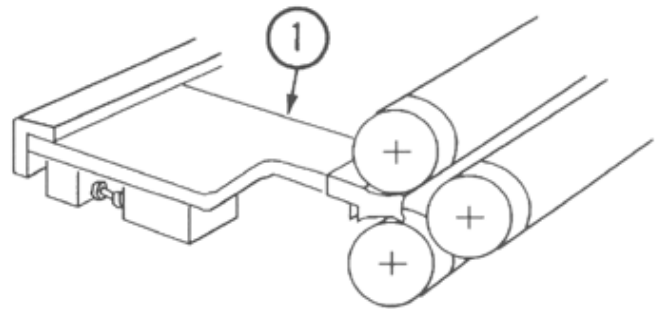

Figure 27

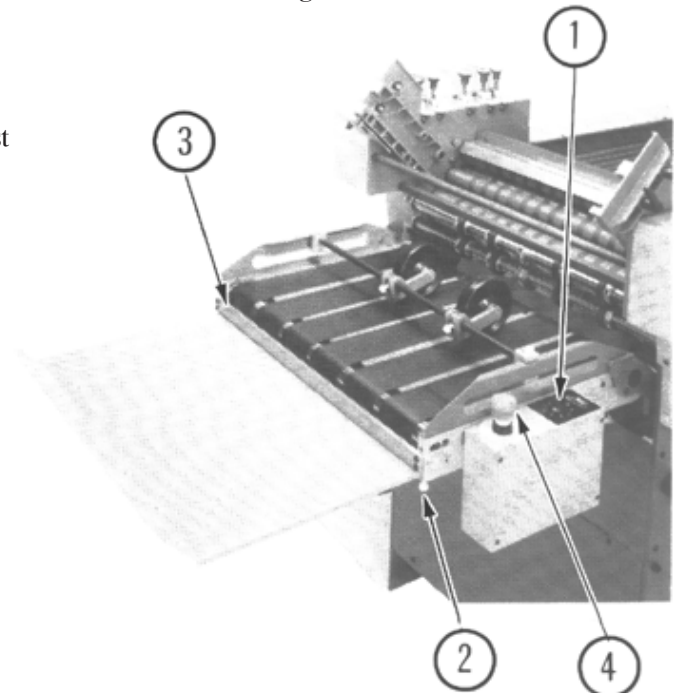

Figure 28

SCORING/SLITTING/PERFORATING

Your new folder is capable of many different applications that compliment the folding performance and provide for greater productivity.

The folder is equipped with slitter shafts that are quickly set up for the required operation. These shafts accommodate the mounting of the standard and optional accessories available that perform scoring, slitting and perforating functions.

It is important to note that accessories from previous model Baumfolder machines with 7/8" diameter slitter shafts are still adaptable to your new folder.

1.0 Slitter Shaft Accessories Removal

To remove slitter shafts, remove knob (Figure 29-1). Insert knob into the center of the slitter housing (29-2) and remove the housing, using the knob. Add or remove the parts needed for the current job using the wrench (Figure 30) provided with the machine. See the following pages for more information on perfining, scoring, and slitting. Reinstall slitter housing and knob before starting the machine.

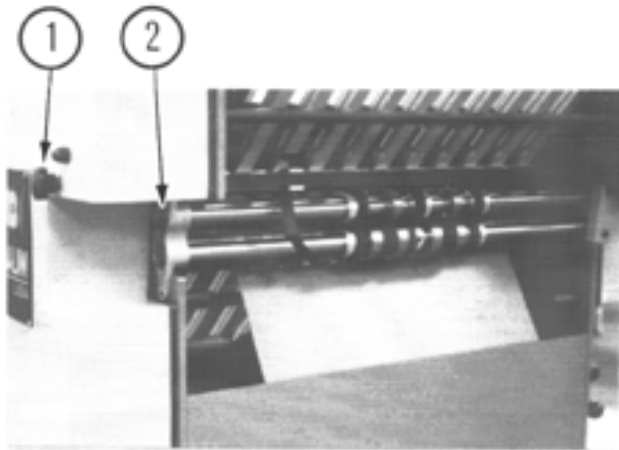

Figure 29

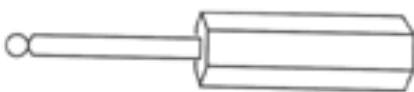

Figure 30

1.1 Scoring

The folder can be used to score a sheet and deliver it flat, or to score a sheet after a fold or folds have been made.

To ensure accuracy in making right angle folds, always score the sheet where the fold or folds are to be made. This applies in all instances when a perforator cannot be used.

Various weights of stock with few or numerous folds require a different type of score. Some jobs require a narrow, sharp score, usually when the folds are few, and a fuller, more rounded score when the job becomes bulky.

The new Baum Adjustable Score Assembly (Figure 31) makes it easier to adjust the depth of your score. This is adaptable for any Baum folder with 7/8-inch diameter slitter shafts.

The Baum Adjustable Score Assembly consists of two special score collars which are connected by two adjusting screws. These screws provide precise control over the compression of the rubber score tire, which in turn determines the depth of the score.

For previous type scoring accessory setup, see Figure 32. Scoring blades can be mounted on either upper or lower shaft. They should be placed



Figure 31

Adjustable Score Assembly

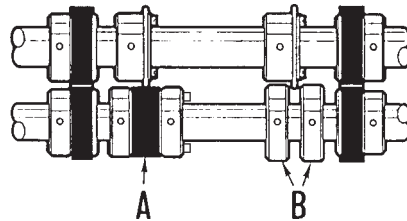
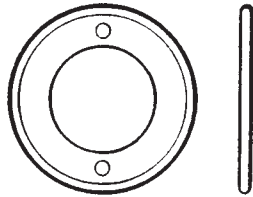

Figure 32

so that the fold is made with, rather than against the scoring, or, in a continuing direction to the pressure or crease that has been applied by the scoring blade.

32-A) Score directly on the wide, soft rubber tire with a collar mounted at either side. By this method, depth of the scoring can be increased by compressing the collars to expand the tire.

32-B) For a wide, well-rounded score, the two steel collars alone are sometimes used. Sharpness and depth of the score can be controlled by regulating the distance the collars are placed away from the scoring blade.



Scoring Blades

Figure 33

1.2 Perforating

The folder may be used for perforating either the heads of booklets (to allow the air to escape in making right-angle folds) or to slot perforate sheets delivered flat, using blades and strippers best adapted for a particular job.

All perforating blades are mounted on the upper shaft and run in a grooved steel collar on the lower shaft with the flat side of the blade just touching a side of the groove. When doing book work, perforator blades should be mounted with the bevel side of the blade toward the following bank of fold rollers. (See Figure 34). When mounted in this manner there is slightly less tendency for the sections of the signature to come apart and less tendency for one section to pull out of line with another. This is particularly true when folding in an up fold plate.

A stripper must be used with each perforation. The forked spring steel stripper requires a little more care in mounting and is most often used when perforating only, as there is less tendency for the perforated sheet to break apart.

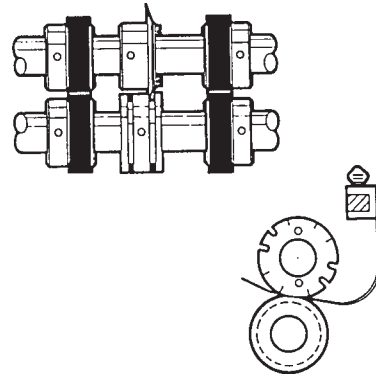
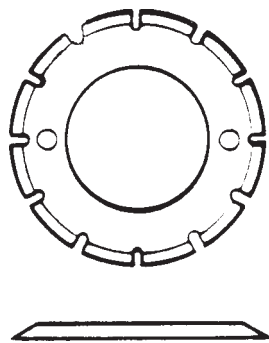

Figure 34



Perforator Blades

Part #	Description
07618	6 Tooth Perforator
06605	12 Tooth Perforator
07895	15 Tooth Perforator
07896	18 Tooth Perforator
29629	20 Tooth Perforator
07619	24 Tooth Perforator
06798	31 Tooth Perforator
07791	41 Tooth Perforator
11962	64 Tooth Perforator

Figure 35

1.3 Slitting (Cutting) Sheets

Folders may be used to cut folded or flat sheets apart. The general set up for blades and collars is shown in the Figure 36. Two or more cuts may be made if duplicate sets of slitters are used.

Be careful when mounting slitter blades to collars in order to avoid ragged edges which can be caused by two conditions:

- 1) Nicks or burrs on the collars or blades. Remove carefully by filing or using a fine piece of emery cloth.
- 2) Incorrect mounting of blades caused by tightening with the wrong type screw. Always use flat head screws on the side of blades and blade holders which are countersunk.

Before tightening the blade to the collar, slide the blade with the collar loosely attached on the end of the shaft. Then tighten securely to align both blade and collar, and allowing free horizontal movement. Place the blade on the upper shaft in the position where the cut is to be made. Then move the blade on the lower shaft so that the two blades are pressed snugly together. Too much space between the blades will produce a ragged cut.

Figure 36-1 shows a spacing washer mounted on the outside of the blade for reinforcement. This helps prevent bending or twisting when running very heavy work or any job containing a large number of folds.

Space the pull out tires evenly to support the sheet.

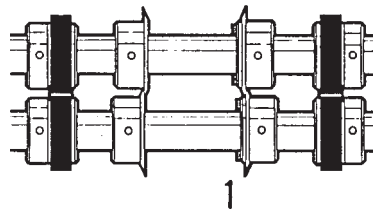
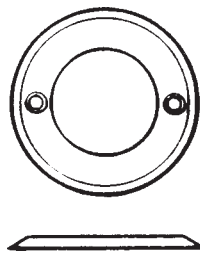

Figure 36



Slitter Blades

Part #	Description
06378	3/32" Thick Countersunk Flat Side
06804	3/32" Thick Countersunk Bevel Side
15240	.062 Thick Countersunk Flat Side
15241	.062 Countersunk Bevel Side
15573	Hollow Ground Countersunk Flat Side
15574	Hollow Ground Countersunk Bevel Side

Figure 37

1.4 Trimming Edges of Booklets

Figure 38 shows the setup of cutting blades and strippers for trimming edges of booklets or outer edges of circulars running two or more up.

Cutting blades are attached to blade holder collars so that the bevel of blades on the upper shaft are directed toward the strip being trimmed and the bevel of blades on the lower shaft are directed away from the strip. Blades mounted in this manner tend to turn trimmed edges down which helps guide them to the floor. Blade holder collars are turned out to allow a set of pull-out tires to be placed close to the cutting blades, preventing the sheet from buckling or twisting at the point where the cut is being made.

Use as many additional pull-out tires in the center of the sheet as necessary.

Set the collar, with blade attached, in the proper position on the upper shaft. Then move the collar/blade on the lower shaft so that the flat sides of both blades press snugly together. Too much space between the blades will cause a ragged edge on the finished booklet.

Do not attempt to trim less than one-eighth of an inch. On bulky or heavy sheets a wider trim is necessary.

Figure 38 shows the type strippers used for this work, mounted on the square bar directly above the shafts. Note that one is right, the other left, placed accordingly. It may be necessary to bend the strippers slightly to avoid rubbing on the cross carrier or stacker. Strippers are adjustable for up and down movement.

Trimming a Strip from Center of Sheet

Figure 39 shows the setup for taking a quarter inch trim out of the center of a sheet. Two or more trims may be made as long as duplicate sets of cutters and strippers are used and this setup adhered to.

A strip three sixteenths of an inch wide is the minimum trim. This is the thickness of two of the cutting blades placed together and attached to a blade holder collar. Blades on the upper shaft, for all trims up to one-quarter inch, are attached to one collar. If a strip wider than one-quarter of an inch is to be cut, each blade is attached to an individual collar and any desired width may be cut.

To remove the trim, place the appropriate center stripper between two of the cutting blades, attached to a collar, as shown in Figure 39A.

You will note that the holes in one side of the cutting blades and blade holder collars are countersunk, so that flat head screws can be used to mount blades on the lower shaft, allowing clearance for the stripper which is placed between them. This also allows the cut out strip to pass between the lower blades without encountering screw heads.

Attaching blades to collars is very important and should be done with care. The bevel of the cutting blades on the top shaft should always be directed toward the strip to be trimmed. The bevel of the blades on the lower shaft should be directed away from the strip.

Before the cutting blades are tightened to the blade holder collars, slide both the collar and attached blade on the end of the shaft so that they are accurately aligned. Place cutting blades on the upper shaft to the proper position where the cut is to be made. Then place collars on the lower shaft so that the flat sides of the blades are pressed snugly together. Too much space between the blades will give a ragged edge. Always examine blades for dullness and nicks which will cause the same condition.

When blades are in the proper position, mount the stripper as shown. Be sure the stripper does not touch the sides of the cutting blades.

With this setup, the trimmed out section automatically goes between the blades on the lower shaft, where it is carried down and around and guided to the floor by the stripper wire.

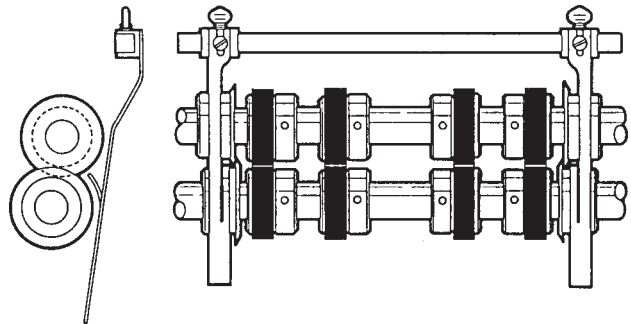

Figure 38

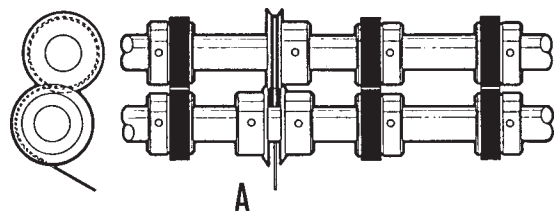

Figure 39

LUBRICATION/MAINTENANCE

Pile Feeder

Vacuum Solenoid Valve

Figure 40

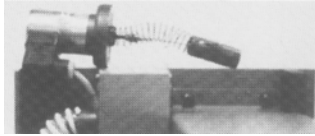

The vacuum at the suction wheel is controlled by a solenoid valve (Figure 40). This can be quickly and easily removed to clean the piston by loosening the clamping springs. Be careful not to damage the piston and cylinder. See Figure 17.

Gear Reducer

Check fluid level annually. Check for wear. Refer to parts manual for part number.

O-Rings (on vacuum wheel)

See Figure 18.

Vacuum Pump

Loss of vacuum and blow can be caused by clogged filters. Check periodically. Check vanes for wear after 15,000 hours of service. Refer to parts manual for ordering parts.

Register

Flat Belt Drive Shaft (hex shape)

Check for wear periodically. Lubricate with Baum Lubricant "W". Lithium base grease or equivalent periodically.

Support Bars

Lubricate the three support bars on which the register guide slides periodically using Lithius base grease.

Folder

Handwheel

Lubricate bi-annually with commercial grade lubricating oil.

Fold Rolls

WARNING: Never clean fold rolls while the machine is running.

With the folder turned off, rub down the fold rolls with a cloth dampened with "Surewash". Never immerse fold rolls into the washing solvent. After cleaning, they should be rubbed down with a clean dry cloth.

Gear Drive

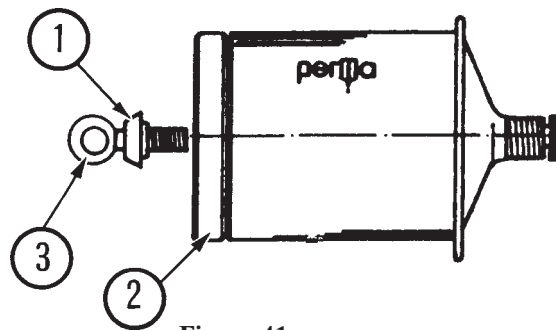

Figure 41

The helical gear drive is lubricated by an automatic grease dispenser located inside the LH guard. Use the label on the LH guard to record lubrication change date [It should be changed every 9 months]. To activate the dispenser, screw the eye bolt (Figure 41-1) into the lid (41-2) of the dispenser until ring (41-3) comes off. Shake the cannister when installing to insure that it rattles, signifying that it has been activated. See parts manual for replacement dispensers.

WARNING: Never open grease dispenser. Even when empty, container remains under pressure. If damaged, caustic liquid may leak out. If contact is made with skin, flush repeatedly with water.

Pullout Tires

Check periodically for wear, uneven tires can cause the sheet to twist.

TECHNICAL SPECIFICATIONS

BAUM 2018

Maximum sheet size	20.5" x 25" [45.7 x 63.5cm]
Minimum sheet size	4" x 6" [10.1 x 15.2cm]
Maximum folder speed	8200 ipm [208m/min]
Maximum pile height	25" [63.5cm]
Minimum fold length	1.57" [40mm]
Maximum fold length	20.5" [45.7cm] (parallel folder)
Slitter shaft diameter	7/8" [22mm]
Electrical	220 Volt, 1 phase, 60 Hz, 23 Amperes
	See serial plate on folder

ACCESSORIES

In addition to the various folding, slitting, perforating and scoring functions the Baum 2018 can perform even more productive functions using the following accessories.

- Jam Detectors
- Remote Control
- Static Eliminator
- Sound Guards
- Gluing Fold Plates

Contact your local Baumfolder Corporation sales representative for further information.

TROUBLESHOOTING

PROBLEM	CAUSE	REMEDY
Sheets stick together particularly along sides.	Inadequate ink drying, cut with blunt guillotine blade.	Fan out thoroughly when piling, increase blower air.
Suction wheels picks up double sheets. Sheets stick together	Excessive suction. Air blow improperly set	Reduce vacuum setting. Increase air blow
Double sheet stop reacts to single sheets.	Set only to single paper thickness.	Correct to double paper thickness. Tighten lock nut.
Sheet twists after suction wheel finishes feed-in.	Side Guide on register set too far back. Too few marbles at start of side gage. Suction gap too short.	Bring guide plate forward. Increase number of marbles if necessary. Increase gap setting.
Sheet leading edge buckles on register or lower sheets are being pushed forward.	If the leading edge of the sheet is being buckled, the holder tongue below the suction wheel is too high; if too low, sheets are pushed forward. Dirty valve piston sticking.	Adjust holder tongue accordingly. Clean.
Sheets fails to run into the buckle plate.	Only at 1st buckle plate: A curl in the sheet can cause the leading-edge to bend up or down thus missing the upper or lower buckle throat. On all buckle plates: sheet missing the buckle plate underlips.	Fit sheet deflector to 1st buckle and fold in 3rd buckle plate. Advance lower buckle plate lips accordingly.
Sheets fails to re-emerge from buckle plate.	Sheet unable to buckle as buckle space too small. Folding rollers blunt or clogged with ink. Inadequate inside clearance in buckle plate.	Set lower buckle plate lip further back. Wash off rollers with the type of rubberised-cloth cleaning agent used in offset work. Increase clearance as necessary.

TROUBLESHOOTING - continued

PROBLEM	CAUSE	REMEDY
Sheets fails to re-emerge from buckle plate.	Product too thick for folding. Not enough roll pressures.	Consult Baum technical rep. Check Baumset settings.
Sheet remains lying on the roller table of the 2nd station or fails to run into the 1st buckle plate of the 2nd folding station.	Electrostatic charge in product caused by friction with rollers and deflectors and also relatively low humidity. Damping rods and sheet holder set too low.	Fit discharge unit at the exit to the 1st station or arrange for appropriate humidity on the premises. Raise as necessary.
Wrinkling after the 1st fold, either across or parallel.	Register guide not at right-angles to the folding rollers. Sheet drawn too sharply against the register guide causing a wave to form. Buckle plate feed stop not parallel to the incoming sheet edge. Folding rollers set too tight.	Set angle correctly. Insert fewer balls or use lighter ones. Correct buckle plate stop setting. Slacken roller setting.
Crooked perforation after 1st fold.	Register guide and buckle plate stop not at right angles to each other. Faulty setting of folding rollers and slitter shaft. Lower buckle plate lip crooked.	Reset. Check and reset as necessary. Set to zero position.
Sheet corners buckled up or down after the 1st fold.	Sheet deflector set too low.	If the corners are buckled upwards, set the upper sheet deflectors back evenly; if the corners are buckled downwards, the lower deflectors must similarly be set back evenly by underlaying pieces of card. In no circumstances alter the basic setting of the deflectors.

OPERATING TIPS

Setup

When setting up a job on your folder, watch so the sheet doesn't end up with either the RH or LH edge along the edge of a fold pan or register plate. This could kick it over causing inaccurate folding.

Brass Tipped Screws

When replacing screws in collars and various other assemblies, be sure to note if they are brass tipped screws. Using non-brass screws as replacements will cause scarring of the shaft, making collars difficult to move.

Static Electricity

If you do not have an electrical static eliminator, here are some ideas to help reduce static electricity:

- Make sure the machine frame is grounded.
- Try using static tinsel across the register table and feeder.
- Locate the folder out of direct drafts such as doorways and air vents.
- Cover jobs with plastic between the press and the folder if much time will elapse before the job is to be run.

Cutting Blade Wear

To help extend the life of all cutting blades, check for possible burrs on the mounting collar. Lay a sheet of emery cloth on a flat surface and rub the collar around a few times to remove any burrs. The blade will now rest flat against the collar, giving a more even rotation.

Measuring Odd Thirds

When measuring odd thirds as needed for a Z-fold for example, on an 11 inch sheet, lay your ruler on a diagonal of 12 inches instead. Mark at four and eight inches, and you will now be able to easily measure 1/3 of the sheet.

Pull-out Bands

Periodically check for wear on the rubber pull-out bands on each slitter shaft. When each sheet passes through the last rolls, there is another 1 3/4 inches left on the sheet before it is completely out of the folder. At this point, the only thing controlling the sheet is the pull out bands. If they are worn or uneven, the sheet can twist after dropping out of the rolls when travelling that last 1 3/4 inches. Be sure when replacing these worn pull-out bands that you replace the complete set, so you will always have an even pull on both sides.

Slitter Shaft Setup

Here is an easy way to set up your slitter shaft accessories. Mark up a dummy sheet with the scores, perforations, etc. locations. Roll through by hand and position your slitter shaft accessories accordingly. Also, keep all set

screws for the slitter shaft accessories facing out, so you don't have to turn the shafts to get to the screws.

TIPS FOR FOLDING

The following section contains a number of hints drawn from practical experience for the setting up and adjustment of folding machines.

Roller Setting for Accordion and Letter Folding

The rollers used for these types of folds must be set only to single paper thickness. The folding rollers following the final fold must, however, be set once more to the total thickness of the paper passing through.

Processing Thin Printing Stock

It is essential that the folding rollers be adjusted with maximum precision.

Lightweight printed stock is more easily folded when the paper is slightly moist as this imparts a greater degree of stiffness. For sheet transportation on the register table and at the right-angle folds, as few marbles as possible should be used and these should be of light weight.

When lightweight printed stock is being folded, the folding machine should be started up as slowly as possible. Only after the necessary precision adjustments have been made should the machine speed be increased in accordance with the paper. It is essential to ensure that the speed is increased only to a point where quality is maintained.

Folding Roller Adjustment

Contrary to popular opinion, paper strips trimmed for this purpose should not be inserted between the clamp blocks of the Baumset. The strips should be folded according to the required pattern and inserted with the folds.

Paper Grain in Letter Folds

With paper of up to 90 g/m, the three-directional letter fold can be produced even if the grain is at right angles to the fold. From 90 g/m upwards, better folds are produced if the paper grain runs parallel to the fold.

Using Guide Marbles

The basic rule is that as few marbles should be used as possible. Steel marbles should be used only when necessary for the type of paper and the required fold. Conveyor tapes last longer if unnecessary marbles are removed.

If stream delivery on parallel folding work is not uniform, try using more marbles after the parallel folding station.

A simple rule of thumb is that the thicker the folded sheet becomes from station to station, the greater the load exerted by the balls should be to facilitate sheet movement.

Fixing Crooked Perforations

If misaligned perforations appear after the parallel folding station, first check for correct squareness setting of the register guide relative to the buckle plate stop. If square, the sheet deflector following the last buckle plate must be set back slightly on the side on which the sheet is tending to advance.

Adjustment can be made by inserting a card underlay of suitable thickness. The affected sheet side then has to travel a greater distance, so a perfect perforation can be made without changing the fold position.

Bottom Plate Lip Adjustment

Since paper qualities and thicknesses vary greatly, it is essential that buckle plates are properly adjusted.

With thin papers, the lower buckle lip is brought slightly forward. With thicker paper it must be set further back. The buckle plate configuration is directly related to the thickness and stiffness of the paper being folded. This relationship must be taken into account if a high quality fold is to be achieved.

The adjustments can be made by setting the nuts on the top edge of the buckle plate to give the necessary reading against a scale on the side buckle plate post. A pointer marks the normal setting of the buckle plate. The inside width between the buckle plate section rods can also be varied without altering the setting of the buckle throat.

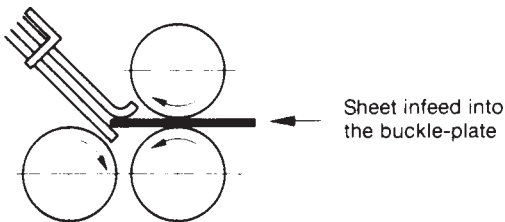
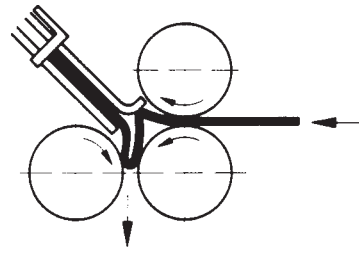
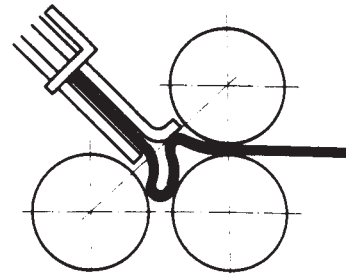

Figure 42



Buckle space too large.
The sheet cannot be controlled on buckling so that, depending on size and shape, different degrees of bending ensue (length differences).

Figure 43



Thin weak papers require a small buckle space and a narrow buckle-plate.
Thick strong papers require a larger buckle space and a wider buckle-plate (bigger internal gap).

Figure 44

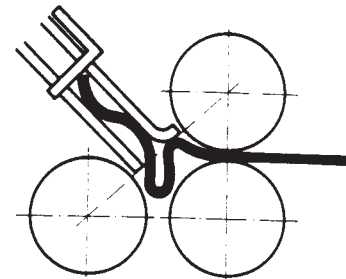

Buckle-plate with too large a gap.
The sheet forms different sized waves parallel to the leading edge. Lacking stiffness, the sheet bends (length differences).

Figure 45

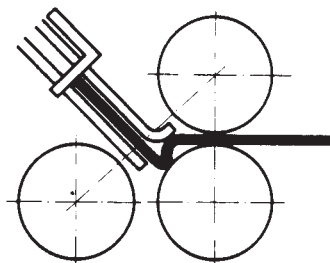

Buckle-space too small.
The sheet is unable to buckle sufficiently to be caught and drawn in by the rollers.

Figure 46

Principles of Mechanical Folding

The buckle folding principle

In buckle folding, each station consists of three rollers and a buckle plate. The first two rollers are arranged one vertically above the other and they carry the incoming sheet into the buckle plate until it reaches a feed guide stop that can be adjusted as required.

The sheet is delivered into the buckle plate at a determined speed. The leading edge strikes the paper stop. Once against the stop the sheet continues to be driven. A buckle forms in the space between the three rollers. As this sags downward, it is picked up by the rotating rollers and the fold is formed as the sheet passes through them.

It can be seen that in this case the folding process is not restricted to any cyclical movement and is thus capable of a very high output.

For each folding station it is possible to fit up to four buckle plates, arranged alternately above and below. Buckle plates that are not required for a particular folding operation can be replaced by sheet deflectors, allowing one or more buckle plates in a folding station to be by-passed. It is thus possible to execute a large number of fold variations.

The gap between the rollers must be set to the thickness of the paper that is passing through. Certain deviations must be made for special types of parallel folding.

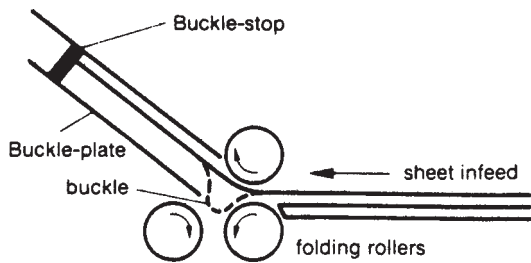

Buckle-folding diagram

Figure 47

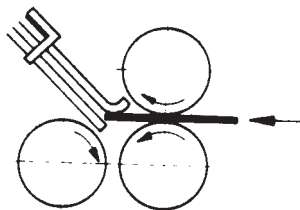

Figure 48

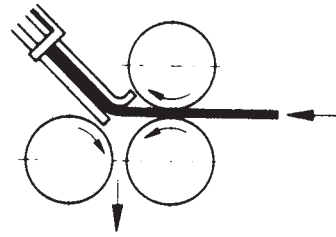

Figure 49

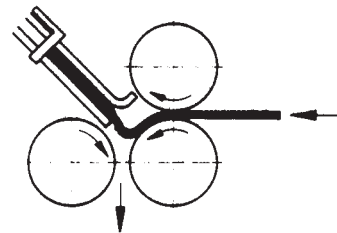

Figure 50

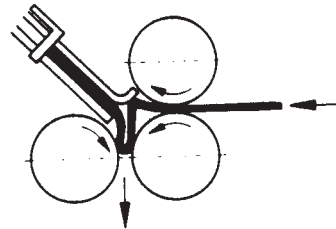

Figure 51

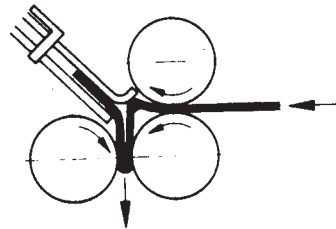
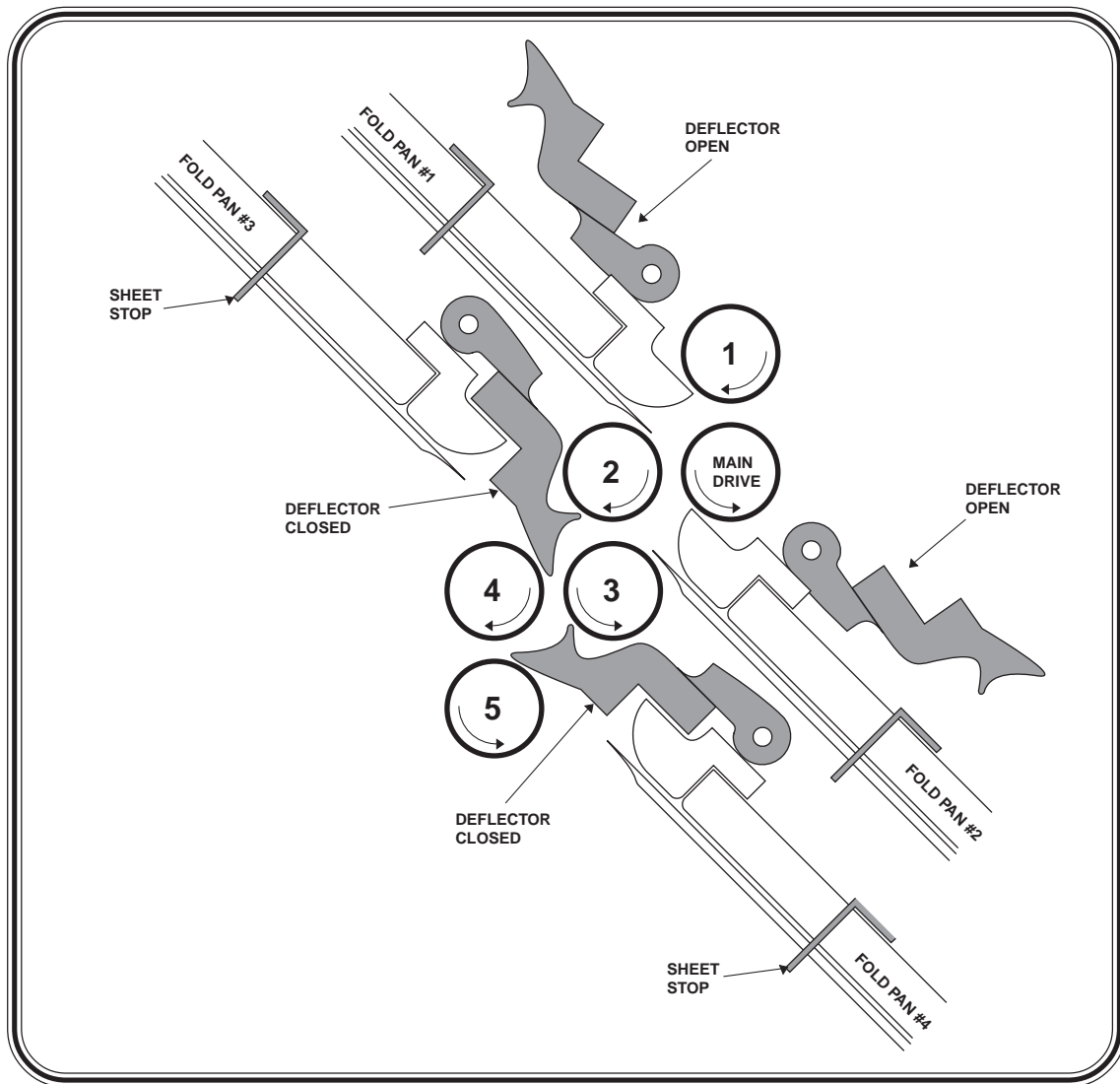

Figure 52



IMPOSITIONS

18 MOST POPULAR FOLDS

On a buckle folder, the sheet is laid flat on a register table and then enters the fold pan assembly where it comes to a stop against the stationary fold plate stop. A series of buckles then forms throughout the sheet. The buckles within the fold pan are kept very small by the narrow channel design. The buckles at the end of the fold pan, however, will be larger. The fold pans and fold rollers are configured such that the large buckle will always form downward, where it can be grabbed by the fold rollers and compressed into a fold.

Look at the figure below. You can see that fold pans #1 and #3 are angled upwards. Because of this and the configuration of the fold rollers, sheets fed into the #1 and #3 fold pans will always be folded up (i.e. so that the “up” surface of the sheet is folded into contact with itself).

Likewise, because foldpans #2 and #4 are angled down, sheets fed into them will be down-folds; the “down” surface of the sheet will be folded into contact with itself.

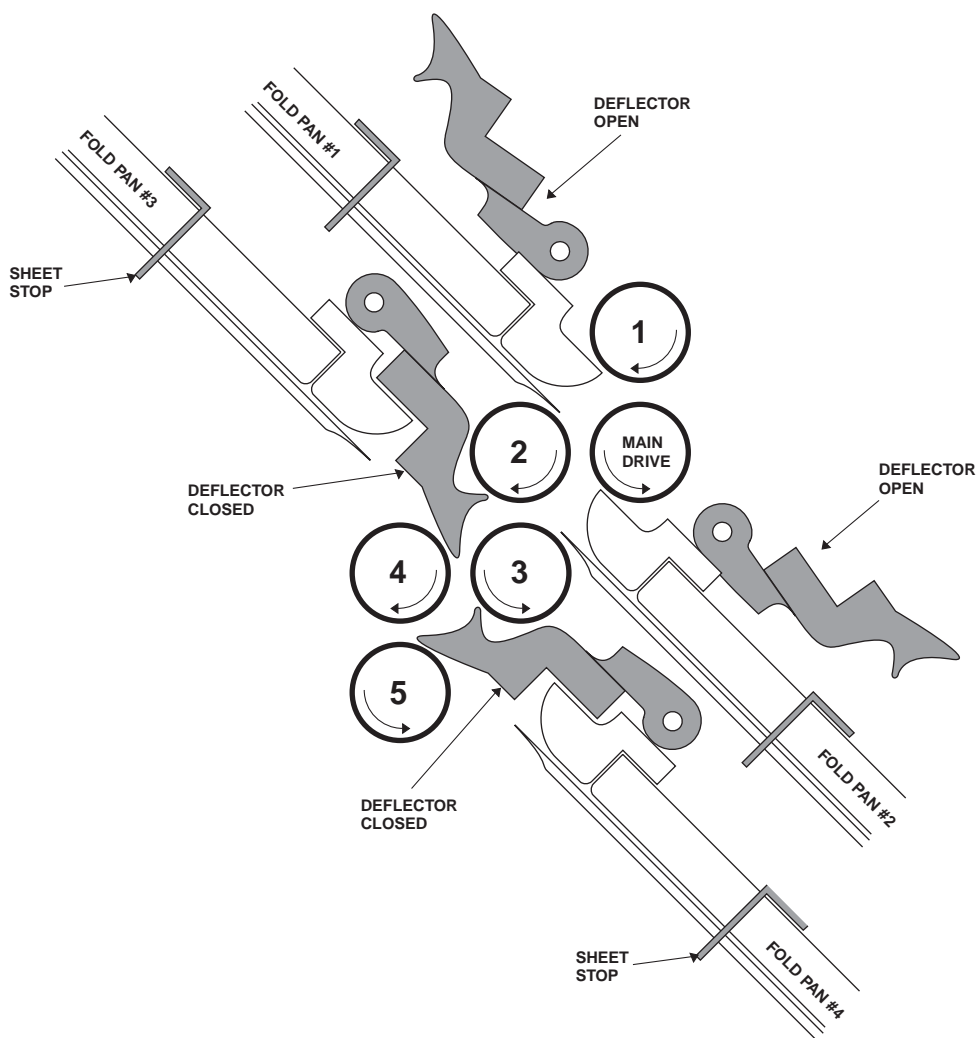

<u>Fold Pan</u>	<u>Fold</u>
#1	UP
#2	DOWN
#3	UP
#4	DOWN

MANUAL USAGE

Use this manual when you need to know how to set-up your folder to end up with a particular folded piece or, if possible, when planning the layout before printing the job. In most cases, the page numbers and their orientations after the fold are included. Below is an explanation of how to read the diagrams in this manual. On the next page is a quick explanation of the basic theory of buckle folding. Although reasonable care has been taken to assure accuracy, Baumfolder Corporation does not assume any responsibility for any errors that might inadvertently be contained in this manual. When trying a new fold, it is always advisable to set up a test run to check for potential problems.

1. Refer to the diagram below. Visualize the sheet to be folded lying flat on the register table. The edge toward the fold rolls is called the **“LEADING EDGE”**. The paper edge under the register guide will be referred to as the **“SIDE GUIDE”**.

In this manual, each folding diagram has been rotated clockwise 90 degrees from what is visualized below so that they appear as pictured to the right. The dotted lines represent the creases where the paper has been folded.

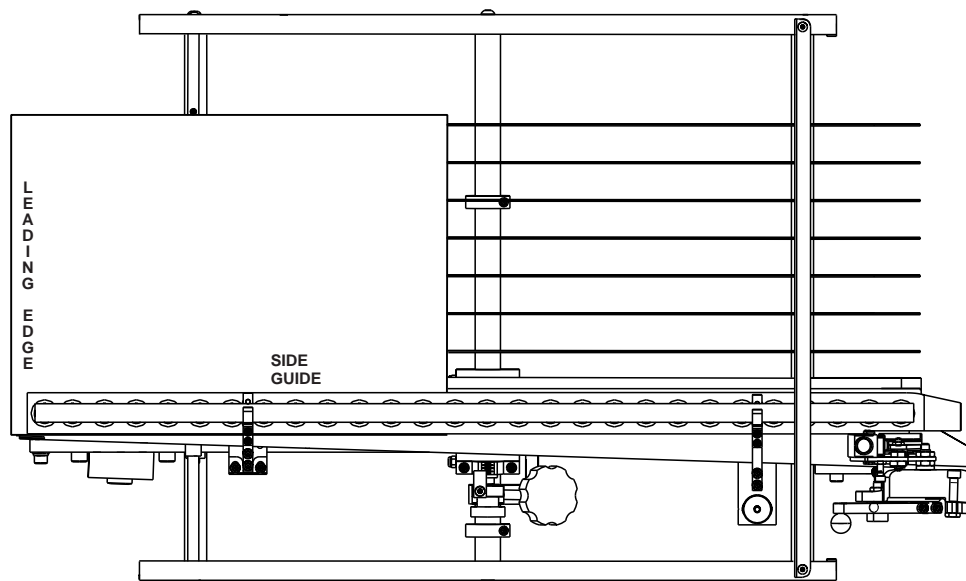
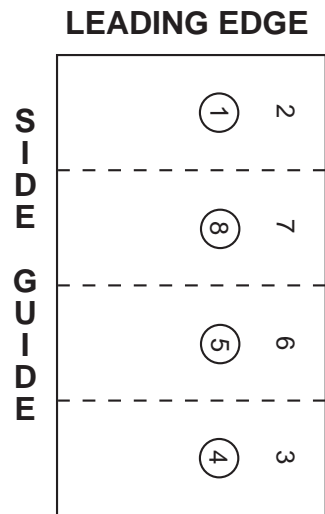

TYPICAL LAYOUT AND SHEET ORIENTATION

Each numbered Imposition Block in this manual contains:

- A. Imposition Title
- B. Fold Pans Used
- C. Sheet Layout
- D. Folded Sample

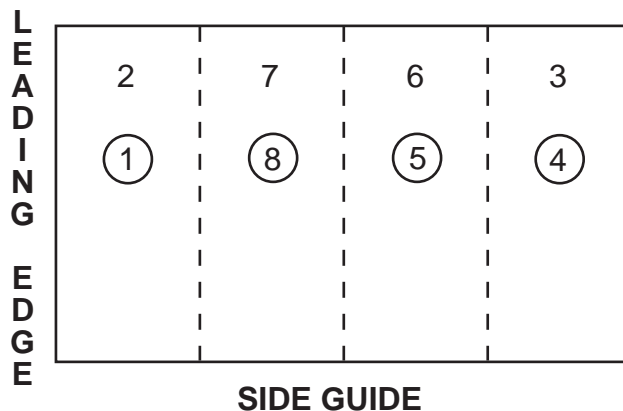

2. Dashed lines represent folds.
Page numbers or letters without circles are face up.
Page numbers or letters with circles are on the underside of the sheet.
When letters are used, folds are to be made “A” to “A”, “B” to “B”, etc.
3. In order to use your Imposition Manual properly, note that the pans in each folding section are numbered conventionally as follows:

PARALLEL FOLDER

- #1 (UP)
- #2 (DOWN)
- #3 (UP)
- #4 (DOWN)

1st STATION (8 page)

- #1 (UP)
- #2 (DOWN)
- #3 (UP)
- #4 (DOWN)

2nd STATION (16 page)

- #1 (UP)
- #2 (DOWN)
- #3 (UP)
- #4 (DOWN)

3rd STATION (32 page)

- #1 (UP)
- #2 (DOWN)

NOTES

1. When planning an imposition, check your folded layout for proper page numbers and guide edges. Verify that your folder is large enough to do the job, that is, that the fold pan depths are sufficient for the folds desired.
2. If the desired imposition is unusual, try the stock on the folder *before printing* (make a trial folding run).
3. Use the most logical layout and avoid unnecessary problems such as air pockets and adverse paper grain.
4. For better results, use scores whenever possible.
5. There are alternate ways of making many of these impositions; those presented herein are in common use to achieve the results shown. An experienced operator will often develop alternate methods to achieve the same results.

1

4-PAGE

Parallel: 1
May be folded two or more up and cut apart.

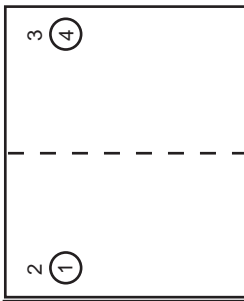
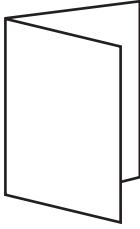

2

4-PAGE, DOUBLE IMPOSITION

Parallel: 1, 2, 3
May be folded two or more up and cut apart.
Trim edge after folding.

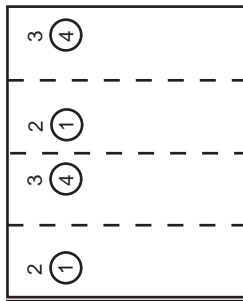
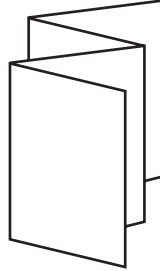

3

6-PAGE, STANDARD

Parallel: 1, 3
May be folded two or more up and cut apart.

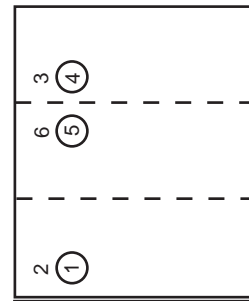
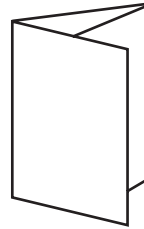

4

6-PAGE, ACCORDION

Parallel: 1, 2
May be folded two or more up and cut apart.

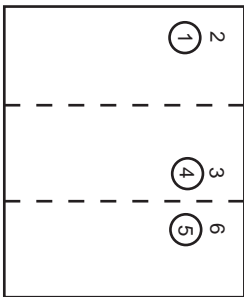
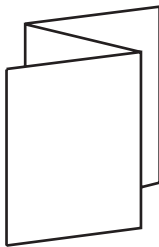

5

8-PAGE, PARALLEL IMPOSITION

Parallel: 1, 2
May be folded two or more up and cut apart.

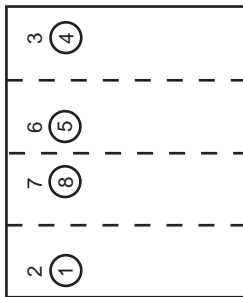
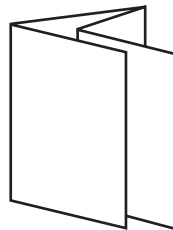

6

8-PAGE, RIGHT ANGLE

Parallel: 1
8-Page: 1

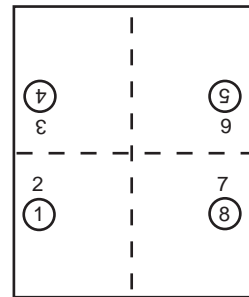
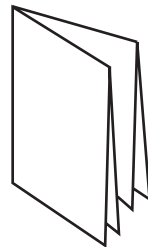

7 8-PAGE, TWO RIGHT
ANGLE OBLONG
Parallel: 1
8-Page: 1

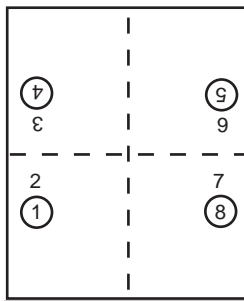
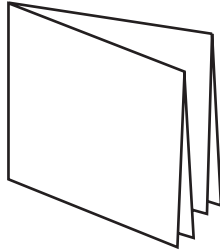

8 8-PAGE, RIGHT
ANGLE DOUBLE
IMPOSITION
Parallel: 1
8-Page: 1, 2, 3

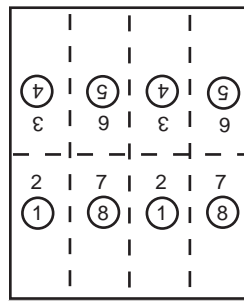
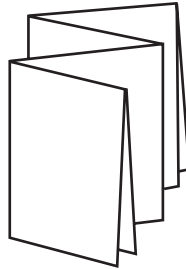

9 8-PAGE, PARALLEL
OVER & OVER
Parallel: 1, 2, 4
May be run two or
more up and cut apart.

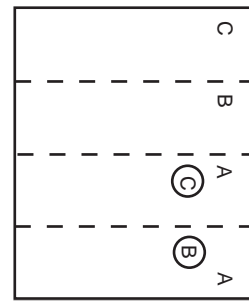
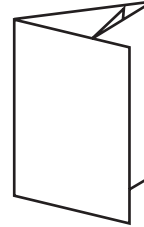

10 12-PAGE BOOK,
SADDLE STITCH
Parallel: 1, 2
8-Page: 2

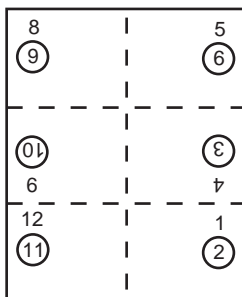

11 12-PAGE BOOK,
SADDLE STITCH
Parallel: 1, 2
8-Page: 1

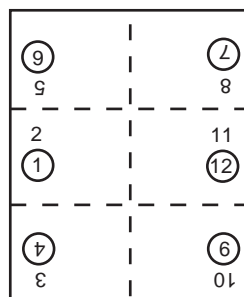
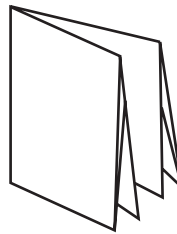

12 12-PAGE LETTER
FOLD, HEADS OUT
Parallel: 1
8-Page: 1, 2

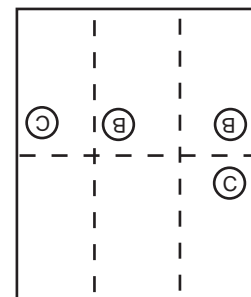
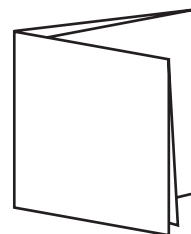

13 12-PAGE LETTER FOLD, HEADS IN
 Parallel: 1
 8-Page: 1, 3

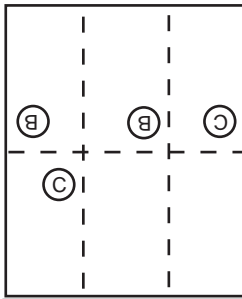
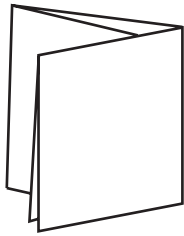

14 12-PAGE LETTER FOLD, ACCORDION
 Parallel: 1
 8-Page: 1, 2

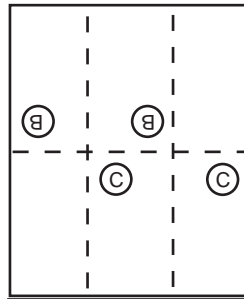
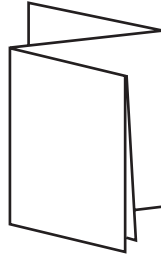

15 16-PAGE, THREE RIGHT ANGLE BOOK IMPOSITION
 Parallel: 1 8-Page: 1
 16-Page: 1 May be run two or more up and cut apart.

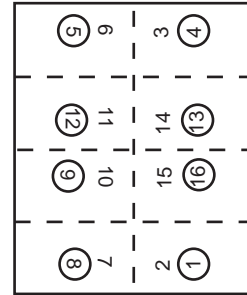
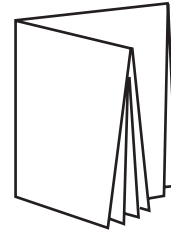

16 12-PAGE FOLDER, HEADS OUT
 Parallel: 1
 8-Page: 1, 2

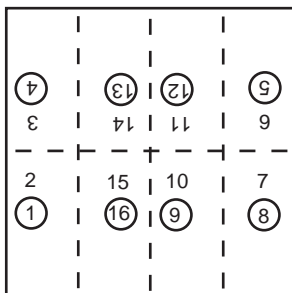
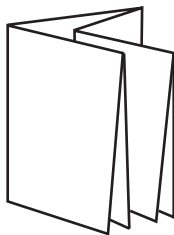

17 24-PAGE BOOKLET
 Parallel: 1, 2
 8-Page: 1, 2

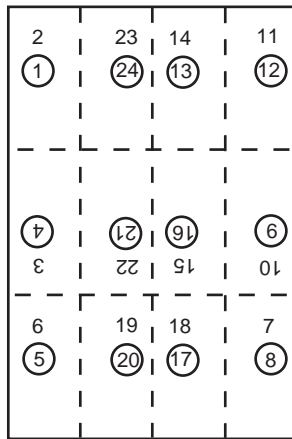
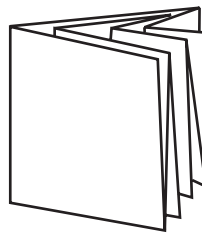

18 32-PAGE BOOK
 Parallel: 1, 2, 3
 8-Page: 1, 2

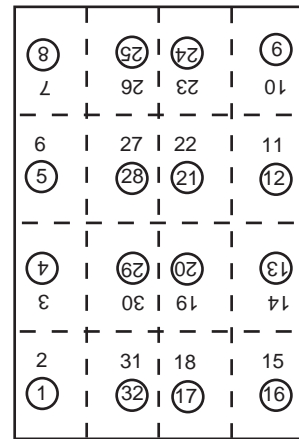
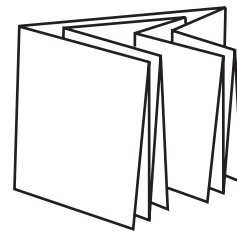

Baumfolder has authorized dealers located throughout the United States.

Call toll free, **1-800/543-6107** for parts or the number of your nearest authorized dealer.

**BAUMFOLDER
CORPORATION**

Producing Bindery Equipment Since 1917

1660 Campbell Road
Sidney, Ohio 45365-0728
Phone; 937/492-1281 or 800/543-6107
Fax; 800/452-0947
Internet: www.baumfolder.com
E-mail: baum@brightnet.com

